

FI-611/90

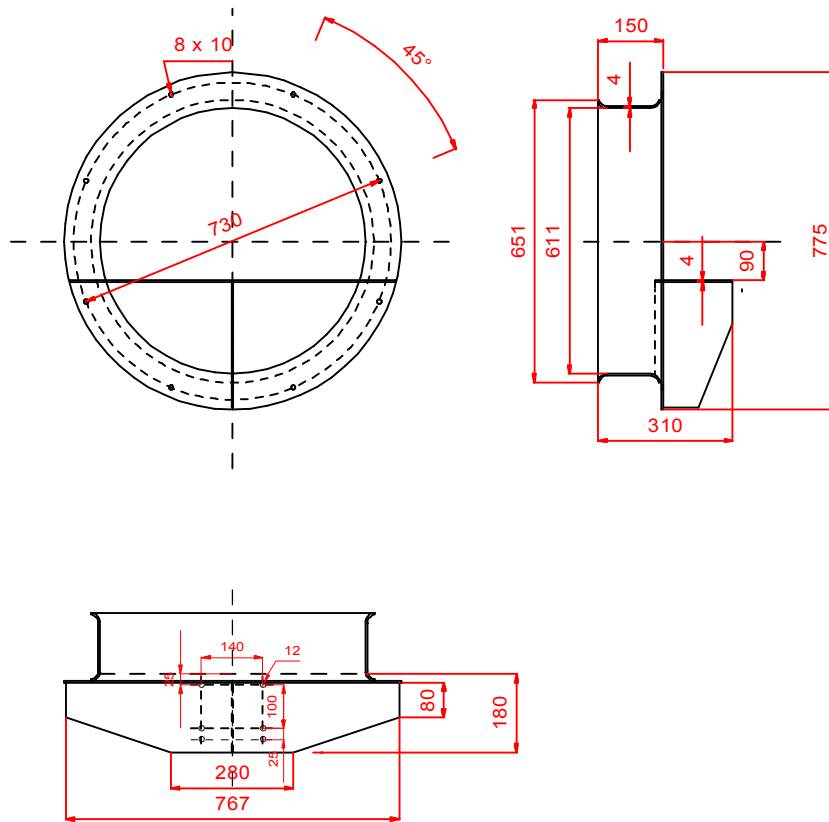

									FI-611/090
								5,4 kg	ALU 1050