

# DIGIDRIVE SK

## Getting started guide (sizes A to D)

## **General Information**

The manufacturer accepts no liability for any consequences resulting from inappropriate, negligent or incorrect installation or adjustment of the optional operating parameters of the equipment or from mismatching the variable speed drive with the motor.

The contents of this guide are believed to be correct at the time of printing. In the interests of a commitment to a policy of continuous development and improvement, the manufacturer reserves the right to change the specification of the product or its performance, or the contents of the guide, without notice.

All rights reserved. No parts of this guide may be reproduced or transmitted in any form or by any means, electrical or mechanical including photocopying, recording or by an information storage or retrieval system, without permission in writing from the publisher.

## **Drive software version**

This product is supplied with the latest software version. If this drive is to be connected to an existing system or machine, all drive software versions should be verified to confirm the same functionality as drives of the same model already present. This may also apply to drives returned from LEROY-SOMER. If there is any doubt please contact LEROY-SOMER.

The software version of the drive can be checked by looking at Pr **11.29** and Pr **11.34**. This takes the form of xx.yy.zz where Pr **11.29** displays xx.yy and Pr **11.34** displays zz. (e.g. for software version 01.01.00, Pr **11.29** = 1.01 and Pr **11.34** displays 0).

## **Environmental statement**

LEROY-SOMER is committed to minimising the impacts of its manufacturing operations. To this end, we operate an Environmental Management System (EMS) which is certified to the International Standard ISO 14001.

The electronic variable-speed drives manufactured by LEROY-SOMER have the potential to save energy and (through increased machine/process efficiency) reduce raw material consumption and scrap throughout their long working lifetime.

When the products eventually reach the end of their useful life, they must not be discarded but should instead be recycled by a specialist recycler of electronic equipment. Recyclers will find the products easy to dismantle into their major component parts for efficient recycling. Many parts snap together and can be separated without the use of tools, whilst other parts are secured with conventional fasteners.

Product packaging is of good quality and can be re-used. Large products are packed in wooden crates, while smaller products come in strong cardboard cartons which themselves have a high recycled fibre content. If not re-used, these containers can be recycled. Polythene, used on the protective film and bags for wrapping product, can be recycled in the same way.

When preparing to recycle or dispose of any product or packaging, please observe local legislation and best practice.

## **REACH legislation**

EC Regulation 1907/2006 on the Registration, Evaluation, Authorisation and restriction of Chemicals (REACH) requires the supplier of an article to inform the recipient if it contains more than a specified proportion of any substance which is considered by the European Chemicals Agency (ECHA) to be a Substance of Very High Concern (SVHC) and is therefore listed by them as a candidate for compulsory authorisation.

For current information on how this requirement applies in relation to specific LEROY-SOMER products, please approach your usual contact in the first instance.

Issue Number: 9

Software: 01.08.00

---

# Contents

---

<b>1</b>	<b>Safety information .....</b>	<b>4</b>
1.1	Warnings, Cautions and Notes .....	4
1.2	Electrical Safety - general warning .....	4
1.3	System design and safety of personnel .....	4
1.4	Environmental Limits .....	4
1.5	Access .....	5
1.6	Fire protection .....	5
1.7	Compliance and regulations .....	5
1.8	Motor .....	5
1.9	Mechanical brake control .....	5
1.10	Adjusting parameters .....	5
1.11	Electrical installation .....	6
<b>2</b>	<b>Rating data .....</b>	<b>7</b>
<b>3</b>	<b>Mechanical installation .....</b>	<b>9</b>
3.1	Fire protection .....	9
3.2	Terminal dimensions and location .....	10
<b>4</b>	<b>Electrical installation .....</b>	<b>13</b>
4.1	Power terminal connections .....	13
4.2	Ground leakage .....	15
4.3	EMC .....	16
4.4	Control terminals I/O specification .....	17
<b>5</b>	<b>Keypad and display .....</b>	<b>20</b>
5.1	Programming keys .....	20
5.2	Control keys .....	20
5.3	Selecting and changing parameters .....	21
5.4	Saving parameters .....	22
5.5	Parameter access .....	22
5.6	Security codes .....	23
5.7	Setting drive back to default values .....	23
<b>6</b>	<b>Parameters .....</b>	<b>24</b>
6.1	Parameter descriptions - Level 1 .....	24
6.2	Parameter descriptions - Level 2 .....	31
6.3	Parameter descriptions - Level 3 .....	41
6.4	Diagnostic parameters .....	41
<b>7</b>	<b>Quick start commissioning .....</b>	<b>42</b>
7.1	Terminal control .....	42
7.2	Keypad control .....	44
<b>8</b>	<b>Diagnostics .....</b>	<b>46</b>
<b>9</b>	<b>Options .....</b>	<b>49</b>
9.1	Documentation .....	50
<b>10</b>	<b>UL listing information .....</b>	<b>51</b>
10.1	UL information (for Digidrive SK size A, B, C and D) .....	51

---

# 1 Safety information

---

## 1.1 Warnings, Cautions and Notes



A **Warning** contains information, which is essential for avoiding a safety hazard.



A **Caution** contains information, which is necessary for avoiding a risk of damage to the product or other equipment.

**NOTE**

A **Note** contains information, which helps to ensure correct operation of the product.

## 1.2 Electrical Safety - general warning

The voltages used in the drive can cause severe electrical shock and/or burns, and could be lethal. Extreme care is necessary at all times when working with or adjacent to the drive.

Specific warnings are given at the relevant places in this guide.

## 1.3 System design and safety of personnel

The drive is intended as a component for professional incorporation into complete equipment or system. If installed incorrectly, the drive may present a safety hazard.

The drive uses high voltages and currents, carries a high level of stored electrical energy, and is used to control equipment which can cause injury.

System design, installation, commissioning and maintenance must be carried out by personnel who have the necessary training and experience. They must read this safety information and this guide carefully.

**The STOP and START controls or electrical inputs of the drive must not be relied upon to ensure safety of personnel. They do not isolate dangerous voltages from the output of the drive or from any external option unit. The supply must be disconnected by an approved electrical isolation device before gaining access to the electrical connections.**

The drive is not intended to be used for safety-related functions.

Careful consideration must be given to the function of the drive which might result in a hazard, either through its intended behavior or through incorrect operation due to a fault. In any application where a malfunction of the drive or its control system could lead to or allow damage, loss or injury, a risk analysis must be carried out, and where necessary, further measures taken to reduce the risk - for example, an over-speed protection device in case of failure of the speed control, or a fail-safe mechanical brake in case of loss of motor braking.

## 1.4 Environmental Limits

Instructions within the supplied data and information within the *Digidrive SK Technical Data Guide* regarding transport, storage, installation and the use of the drive must be complied with, including the specified environmental limits. Drives must not be subjected to excessive physical force.

## 1.5 Access

Access must be restricted to authorized personnel only. Safety regulations which apply at the place of use must be complied with.

The IP (Ingress Protection) rating of the drive is installation dependant. For further information, refer to the *Digidrive SK Technical Data Guide*.

## 1.6 Fire protection

The drive enclosure is not classified as a fire enclosure. A separate fire enclosure must be provided. See section 3.1 *Fire protection* on page 9 for more information.

## 1.7 Compliance and regulations

The installer is responsible for complying with all relevant regulations, such as national wiring regulations, accident prevention regulations and electromagnetic compatibility (EMC) regulations. Particular attention must be given to the cross-sectional areas of conductors, the selection of fuses and other protection, and protective ground (earth) connections.

The *Digidrive SK Technical Data Guide* contains instructions for achieving compliance with specific EMC standards.

Within the European Union, all machinery in which this product is used must comply with the following directives:

2006/42/EC: Safety of machinery

2004/108/EC: Electromagnetic compatibility

## 1.8 Motor

Ensure the motor is installed in accordance with the manufacturer's recommendations. Ensure the motor shaft is not exposed.

Standard squirrel cage induction motors are designed for single speed operation. If it is intended to use the capability of a drive to run a motor at speeds above its designed maximum, it is strongly recommended that the manufacturer is consulted first.

Low speeds may cause the motor to overheat because the cooling fan becomes less effective. The motor should be installed with a protection thermistor. If necessary, an electric force vent fan should be used.

The values of the motor parameters set in the drive affect the protection of the motor. The default values in the drive should not be relied upon.

It is essential that the correct value is entered into parameter **06**, motor rated current. This affects the thermal protection of the motor.

## 1.9 Mechanical brake control

The brake control functions are provided to allow well co-ordinated operation of an external brake with the drive. While both hardware and software are designed to high standards of quality and robustness, they are not intended for use as safety functions, i.e. where a fault or failure would result in a risk of injury. In any application where the incorrect operation of the brake release mechanism could result in injury, independent protection devices of proven integrity must also be incorporated.

## 1.10 Adjusting parameters

Some parameters have a profound effect on the operation of the drive. They must not be altered without careful consideration of the impact on the controlled system. Measures must be taken to prevent unwanted changes due to error or tampering.

## **1.11 Electrical installation**

### **1.11.1 Electric shock risk**

The voltages present in the following locations can cause severe electric shock and may be lethal:

- AC supply cables and connections
- DC bus, dynamic brake cables and connections
- Output cables and connections
- Many internal parts of the drive, and external option units

Unless otherwise indicated, control terminals are single insulated and must not be touched.

### **1.11.2 Isolation device**

The AC supply must be disconnected from the drive using an approved isolation device before any cover is removed from the drive or before any servicing work is performed.

### **1.11.3 STOP function**

The STOP function does not remove dangerous voltages from the drive, the motor or any external option units.

### **1.11.4 Stored charge**

The drive contains capacitors that remain charged to a potentially lethal voltage after the AC supply has been disconnected. If the drive has been energized, the AC supply must be isolated at least ten minutes before work may continue.

Normally, the capacitors are discharged by an internal resistor. Under certain, unusual fault conditions, it is possible that the capacitors may fail to discharge, or be prevented from being discharged by a voltage applied to the output terminals. If the drive has failed in a manner that causes the display to go blank immediately, it is possible the capacitors will not be discharged. In this case, consult LEROY-SOMER.

### **1.11.5 Equipment supplied by plug and socket**

Special attention must be given if the drive is installed in equipment which is connected to the AC supply by a plug and socket. The AC supply terminals of the drive are connected to the internal capacitors through rectifier diodes which are not intended to give safety isolation. If the plug terminals can be touched when the plug is disconnected from the socket, a means of automatically isolating the plug from the drive must be used (e.g. a latching relay).

### **1.11.6 Ground leakage current**

The drive is supplied with an internal EMC filter capacitor installed. If the input voltage to the drive is supplied through an ELCB or RCD, these may trip due to the ground leakage current. See section 4.3.1 *Internal EMC filter* on page 16 for further information and how to disconnect the internal EMC capacitor.

## 2 Rating data

Figure 2-1 Model code explanation

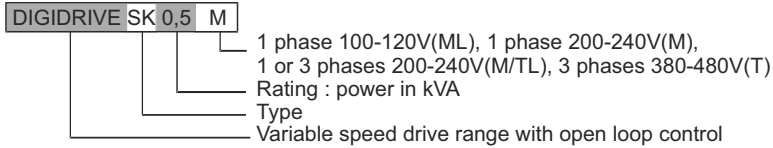

Table 2-1 Digidrive SK, 1 phase, 100 to 120Vac  $\pm 10\%$ , 48 to 62Hz units

Model Number		Size	Nominal motor power		Input fuse rating	Typical full load input current	100% RMS output current	150% overload current for 60s	Minimum braking resistor value	Weight
LS	CT		kW	hp	A	A	A	A	$\Omega$	
SK 0.5 ML	SKA1100025	A	0.25	0.33	10	7.5	1.7	2.55	N/A*	1.0 kg (2.2 lb)
SK 1 ML	SKA1100037	A	0.37	0.5	15	11	2.2	3.3		
SK 1.5 ML	SKB1100075	B	0.75	1.0	25	19.6	4.0	6.0	28	1.4 kg (3.0 lb)
SK 2 ML	SKB1100110	B	1.1	1.5	32	24.0	5.2	7.8		

\*No dynamic braking available with Digidrive SK size A 110V drive.

Table 2-2 Digidrive SK, 1 phase, 200 to 240Vac  $\pm 10\%$ , 48 to 62Hz units

Model Number		Size	Nominal motor power		Input fuse rating	Typical full load input current	100% RMS output current	150% overload current for 60s	Minimum braking resistor value	Weight
LS	CT		kW	hp	A	A	A	A	$\Omega$	
SK 0.5 M	SKA1200025	A	0.25	0.33	6	4.3	1.7	2.55	68	1.0 kg (2.2 lb)
SK 1 M	SKA1200037	A	0.37	0.5	10	5.8	2.2	3.3		
SK 1.2 M	SKA1200055	A	0.55	0.75	10	8.1	3.0	4.5		
SK 1.5 M	SKA1200075	A	0.75	1.0	16	10.5	4.0	6.0		

Table 2-3 Digidrive SK, 1 and 3 phase, 200 to 240Vac  $\pm 10\%$ , 48 to 62Hz units

Model Number		Size	Nominal motor power		Input fuse rating		Typical full load input current		Maximum continuous input current	100% RMS output current	150% overload current for 60s	Minimum braking resistor value	Weight
LS	CT		kW	hp	A		A		A	A	A	$\Omega$	
					1ph	3ph	1ph	3ph	1ph	3ph			
SK 2 M/TL	SKBD200110	B	1.1	1.5	16	10	14.2	6.7	9.2	5.2	7.8	28	1.3 kg (2.9 lb)
SK 2.5 M/TL	SKBD200150	B	1.5	2.0	20	16	17.4	8.7	12.6	7.0	10.5	28	1.4 kg (3.0 lb)
SK 3.5 M/TL	SKCD200220	C	2.2	3.0	25	20	23.2	11.9	17.0	9.6	14.4	28	2.1 kg (4.6 lb)
SK 4.5 M/TL	SKDD200300	D	3.0	3.0	25	16	23.6	12.5	16.6	12.6	18.9	20	4.5 kg (9.9 lb)
SK 5 TL	SKD3200400	D	4.0	5.0		20		15.7	19.5	17.0	25.5	20	

**Table 2-4 Digidrive SK, 3 phase, 380 to 480Vac ±10%, 48 to 62Hz units**

Model Number		Size	Nominal motor power		Input fuse rating	Typical full load input current	Maximum continuous input current	100% RMS output current	150% overload current for 60s	Minimum braking resistor value	Weight
			kW	hp	A	A	A	A	A	W	
SK 1 T	SKB3400037	B	0.37	0.5	6	1.7	2.5	1.3	1.95	100	1.2 kg (2.7 lb)
SK 1.2 T	SKB3400055	B	0.55	0.75	6	2.5	3.1	1.7	2.55	100	
SK 1.5 T	SKB3400075	B	0.75	1.0	6	3.1	3.75	2.1	3.15	100	1.3 kg (2.9 lb)
SK 2 T	SKB3400110	B	1.1	1.5	6	4.0	4.6	2.8	4.2	100	
SK 2.5 T	SKB3400150	B	1.5	2.0	10	5.2	5.9	3.8	5.7	100	2.1 kg (4.6 lb)
SK 3.5 T	SKC3400220	C	2.2	3.0	16	7.3	9.6	5.1	7.65	100	
SK 4.5 T	SKC3400300	C	3.0	3.0	16	9.5	11.2	7.2	10.8	55	4.7 kg (10.4 lb)
SK 5.5 T	SKC3400400	C	4.0	5.0	16	11.9	13.4	9.0	13.5	55	
SK 7 T	SKD3400550	D	5.5	7.5	16	12.4	14.3	13.0	19.5	53	4.7 kg (10.4 lb)
SK 10 T	SKD3400750	D	7.5	10.0	20	15.6	16.9	16.5	24.75	53	

**Output frequency**

0 to 1500Hz

**Output voltage**

**110V drives:**

3 phase, 0 to 240Vac (240 Vac maximum set by Pr **08**).

**NOTE**

110V drives contain a voltage doubler circuit on the AC input.

**200V and 400V drives:**

3 phase, 0 to drive rating (240 or 480Vac maximum set by Pr **08**).

**NOTE**

The output voltage can be increased by 20% during deceleration. See Pr **30** on page 34.

**NOTE**

The output frequency can be increased by 20% during deceleration. See Pr **30** on page 34.

**NOTE**

The maximum continuous current inputs are used to calculate input cable and fuse sizing. Where no maximum continuous input currents are indicated, use the typical full load input current values. See *Digidrive SK Technical Data Guide* for cable and fuse data.



## 3 Mechanical installation



### Enclosure

The drive is intended to be mounted in an enclosure which prevents access except by trained and authorized personnel, and which prevents the ingress of contamination. It is designed for use in an environment classified as pollution degree 2 in accordance with IEC 60664-1. This means that only dry, non-conducting contamination is acceptable.

### 3.1 Fire protection

The drive enclosure is not classified as a fire enclosure. A separate fire enclosure must be provided.

For installation in the USA, a NEMA 12 enclosure is suitable.

For installation outside the USA, the following (based on IEC 62109-1, standard for PV inverters) is recommended.

Enclosure can be metal and/or polymeric, polymer must meet requirements which can be summarized for larger enclosures as using materials meeting at least UL 94 class 5VB at the point of minimum thickness.

Air filter assemblies to be at least class V-2.

The location and size of the bottom shall cover the area shown in Figure 3-1. Any part of the side which is within the area traced out by the 5° angle is also considered to be part of the bottom of the fire enclosure.

**Figure 3-1 Fire enclosure bottom layout**

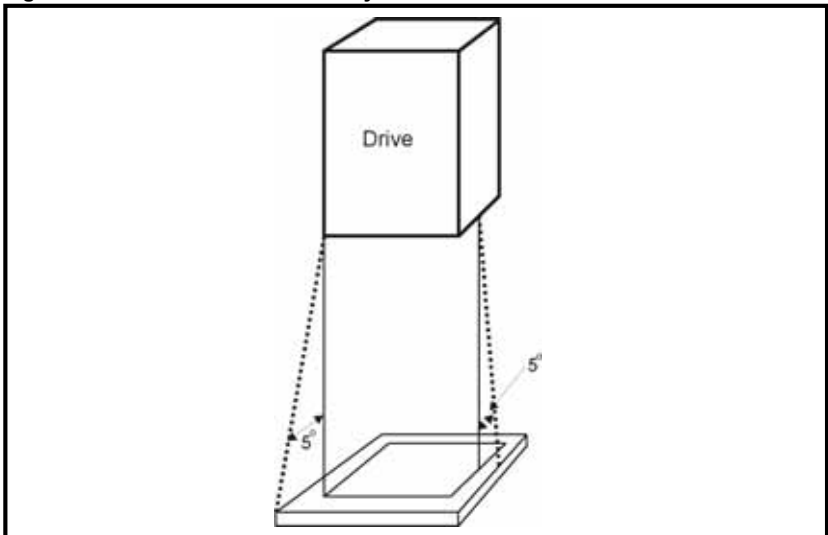

The bottom, including the part of the side considered to be part of the bottom, must be designed to prevent escape of burning material - either by having no openings or by having a baffle construction. This means that openings for cables etc. must be sealed with materials meeting the 5VB requirement, or else have a baffle above. See Figure 3-2 for acceptable baffle construction. This does not apply for mounting in an enclosed electrical operating area (restricted access) with concrete floor.

**Figure 3-2 Fire enclosure baffle construction**

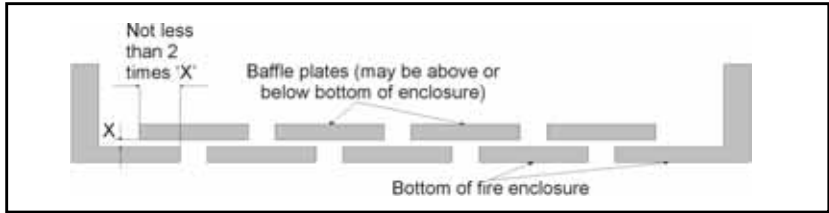

The drive complies with the requirements of IP20 as standard.

## 3.2 Terminal dimensions and location

**Figure 3-3 Digidrive SK dimensions**

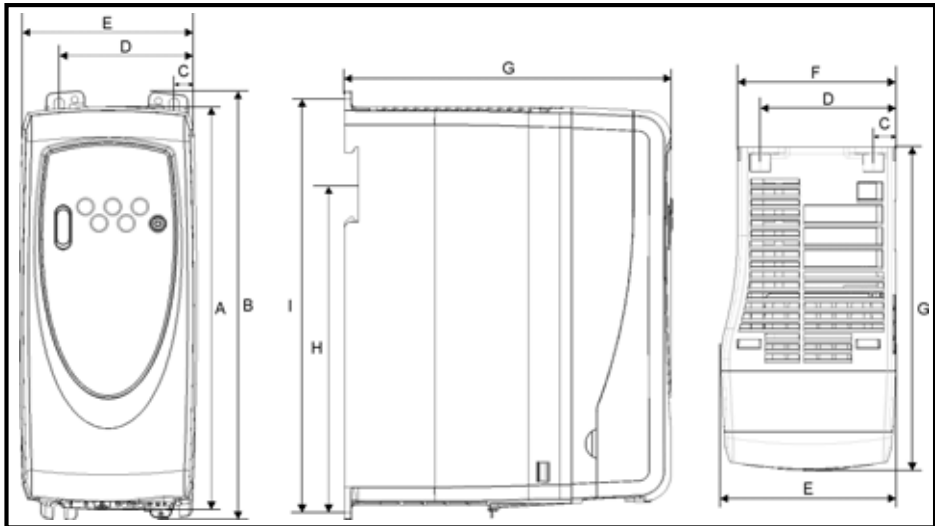

Mounting holes: 4 x M4 holes (size A to C), 4 x M5 holes (size D)

**Table 3-1 Digidrive SK dimensions**

Drive size	A		B		C		D		E		F		G		H*		I	
	mm	in	mm	in	mm	in	mm	in	mm	in	mm	in	mm	in	mm	in	mm	in
A	140	5.51	154	6.06	11	0.43	64	2.52	75	2.95			145	5.71	104	4.09	143	5.63
B	190	7.48	205	8.07	10.9	0.43	65.9	2.6	85	3.35	77	3.0	156	6.15	155.5	6.12	194	7.64
C	240	9.45	258	10.16	10.4	0.41	81.1	3.2	100	3.94	91.9	3.62	173	6.81			244	9.61
D	300	11.81	335	13.19	14.5	0.57	100.5	3.96	115	4.53			198	7.80			315	12.4

\*Size C and D are not DIN rail mountable.

**NOTE**

If DIN rail mounting is used in an installation where the drive is to be subjected to shock or vibration, it is recommended that the bottom mounting screws are used to secure the drive to the back plate.

If the installation is going to be subjected to heavy shock and vibration, then it is recommended that the drive is surface mounted rather than DIN rail mounted.

**NOTE**

The DIN rail mounting mechanism has been designed so no tools are required to install and remove the drive from a DIN rail. Please ensure the top mounting lugs are located correctly on the DIN rail before installation is initiated.

The DIN rail used should conform to DIN46277-3.

**Figure 3-4 Minimum mounting clearances**

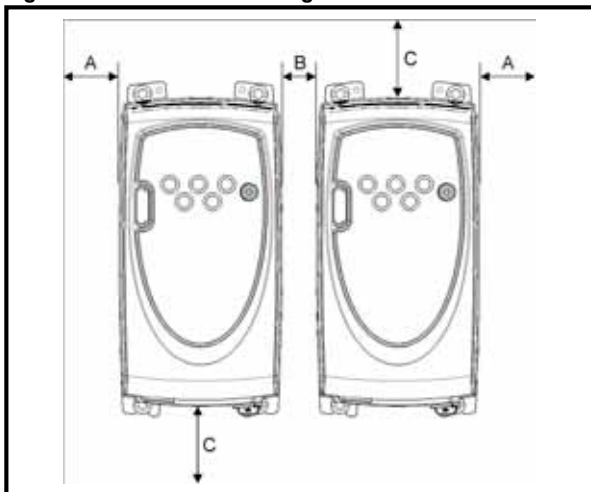

Drive size	A		B		C	
	mm	in	mm	in	mm	in
A	10	0.39	0	0	100	3.94
B ( $\leq 0.75\text{kW}$ )			10*	0.39*		
B ( $\geq 1.1\text{kW}$ ) or B (110V)			0	0		
C			50*	1.97*		
D			0	0		

\*This is the minimum spacing between drives at the base of the drive where it is mounted against a back plate.

**Table 3-2 Tightening torque for mounting feet**

Drive size	Tightening torque
A to C	1.3 to 1.6 Nm
D	2.5 to 2.8 Nm

Figure 3-5 Features of the drive (size B illustrated)

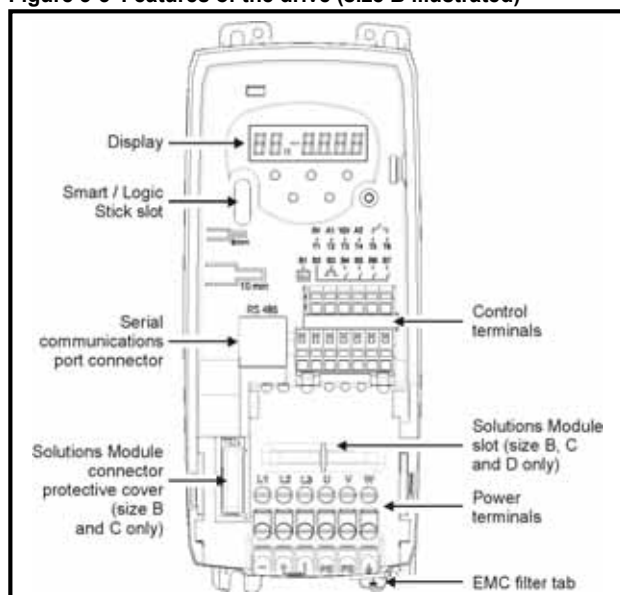

# 4 Electrical installation

## 4.1 Power terminal connections

Figure 4-1 Size A power terminal connections

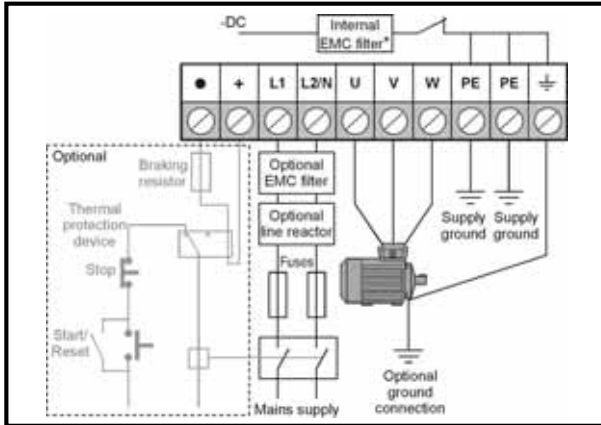
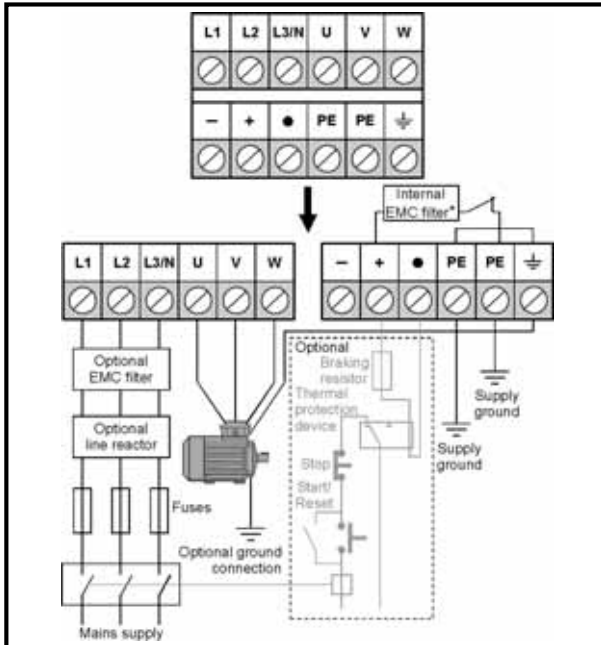

Figure 4-2 Sizes B, C and D power terminal connections



\*For further information, see section 4.3.1 *Internal EMC filter* on page 16.

**NOTE** On the Digidrive SK size B 110V drives, the supply should be connected to L1 and L3/N.

**NOTE** On the Digidrive SK size D, the internal EMC filter is connected to the -DC Bus.

**NOTE** The braking terminals are not available on the size A 110V drive.

**NOTE** On the Digidrive SK size B 110V drives, the -DC bus (-) terminal has no internal connection.



#### Fuses/MCB

The AC supply to the drive must be installed with suitable protection against overload and short circuits. Failure to observe this requirement will cause risk of fire.

See the *Digidrive SK Technical Data Guide* for fuse data.



The drive must be grounded by a conductor sufficient to carry the prospective fault current in the event of a fault. See also the warning in section 4.2 *Ground leakage* relating to ground leakage current.



To avoid a fire hazard and maintain validity of the UL listing, adhere to the specified tightening torques for the power and ground terminals. Refer to the table below.

Frame size	Maximum power terminal screw torque
A	0.5 N m / 4.4 lb in
B, C and D	1.4 N m / 12.1 lb in

### 4.1.1 Starts per hour

#### Electric starts

With the supply permanently connected the number of electronic motor starts per hour is only limited by motor and drive thermal limits.

#### Power starts

The number of starts by connection of the AC supply is limited. The start up circuit will allow for three consecutive starts at 3 second intervals on initial power up. Exceeding the rated number of starts per hour, presented in the table below, could result in damage to the start up circuit.

Frame size	Maximum AC line starts per hour evenly spaced in time
A to D	20



#### Braking resistor: High temperatures and overload protection

Braking resistors can reach high temperatures. Locate braking resistors so that damage cannot result. Use cable having insulation capable of withstanding the high temperatures.

It is essential that the braking resistor be protected against overload caused by a failure of the brake control. Unless the resistor has in-built protection, a circuit like those shown in Figure 4-1 and Figure 4-2 should be used, where the thermal protection device disconnects the AC supply to the drive. Do not use AC relay contacts directly in series with the braking resistor circuit, because it carries DC.

**NOTE** When connecting single phase to a M/TL dual rated 200V unit, use terminals L1 and L3.

**NOTE** For control terminal connections, see Pr **05** on page 25.

**NOTE** For information on the internal EMC filter, see section 4.3.1 *Internal EMC filter*.

## 4.2 Ground leakage

The ground leakage current depends upon the internal EMC filter being installed. The drive is supplied with the filter installed. Instructions for removal of the internal EMC filter are given in section 4.3.2 *Removing the internal EMC filter*.

### With internal EMC filter installed

30 $\mu$ A DC (10M $\Omega$  internal bleed resistor, relevant where DC leakage current is being measured)

#### Size A

##### 1 phase 110V drives

4mA AC maximum at 110V, 50Hz (proportional to supply voltage and frequency)

##### 1 phase 200V drives

10mA AC maximum at 230V, 50Hz (proportional to supply voltage and frequency)

#### Size B

##### 1 phase 110V drives

10mA AC maximum at 110V, 50Hz (proportional to supply voltage and frequency)

#### Size B and C

##### 1 phase 200V drives

20mA AC maximum at 230V, 50Hz (proportional to supply voltage and frequency)

##### 3 phase 200V drives

8mA AC maximum at 230V, 50Hz (proportional to supply voltage and frequency)

##### 3 phase 400V drives

8.2mA AC maximum at 415V, 50Hz (proportional to supply voltage and frequency)

#### Size D

##### 1 phase 200V drives

20.5mA AC maximum at 230V, 50Hz (proportional to supply voltage and frequency)

##### 3 phase 200V drives

8mA AC maximum at 230V, 50Hz (proportional to supply voltage and frequency)

##### 3 phase 400V drives

10.5mA AC maximum at 415V, 50Hz (proportional to supply voltage and frequency)

#### NOTE

The above leakage currents are just the leakage currents of the drive with the internal EMC filter connected and do not take into account any leakage currents of the motor or motor cable.

### With internal EMC filter removed

<1mA

#### NOTE

In both cases, there is an internal voltage surge suppression device connected to ground. Under normal circumstances, this carries negligible current.

 <b>WARNING</b>	<p>When the internal EMC filter is installed, the leakage current is high. In this case, a permanent fixed ground connection must be provided using two independent conductors each with a cross-section equal to or exceeding that of the supply conductors. The drive is provided with two ground terminals to facilitate this. The purpose is to prevent a safety hazard occurring if a connection is lost. Both ground connections are required to meet the required european standard.</p>
---	---

#### 4.2.1 Use of earth (ground) leakage circuit breakers (ELCB) / residual current device (RCD)

There are three common types of ELCB/RCD:

**Type AC** - detects AC fault currents

**Type A** - detects AC and pulsating DC fault currents (provided the DC current reaches zero at least once every half cycle)

**Type B** - detects AC, pulsating DC and smooth DC fault currents

- Type AC should never be used with drives
- Type A can only be used with single phase drives
- Type B must be used with three phase drives

### 4.3 EMC

#### 4.3.1 Internal EMC filter

It is recommended that the internal EMC filter is kept in place unless there is a specific reason for removing it.

If the drive is to be used on an IT supply, then the filter must be removed.

The internal EMC filter reduces radio-frequency emissions into the mains supply. Where the motor cable is short, it permits the requirements of EN 61800-3:2004 to be met for the second environment.

For longer motor cables, the filter continues to provide a useful reduction in emission level, and when used with any length of shielded cable up to the limit for the drive, it is unlikely that nearby industrial equipment will be disturbed. It is recommended that the filter be used in all applications unless the ground leakage current is unacceptable or the above conditions are true.

When the internal EMC filter is used on the Digidrive SK size D, the motor cables (U, V and W) need to be fed twice through a ferrite ring (provided with the drive), so that the drive meets the requirements of operating in the second environment.

#### 4.3.2 Removing the internal EMC filter

Figure 4-3 Removal and re-fitting of internal EMC filter

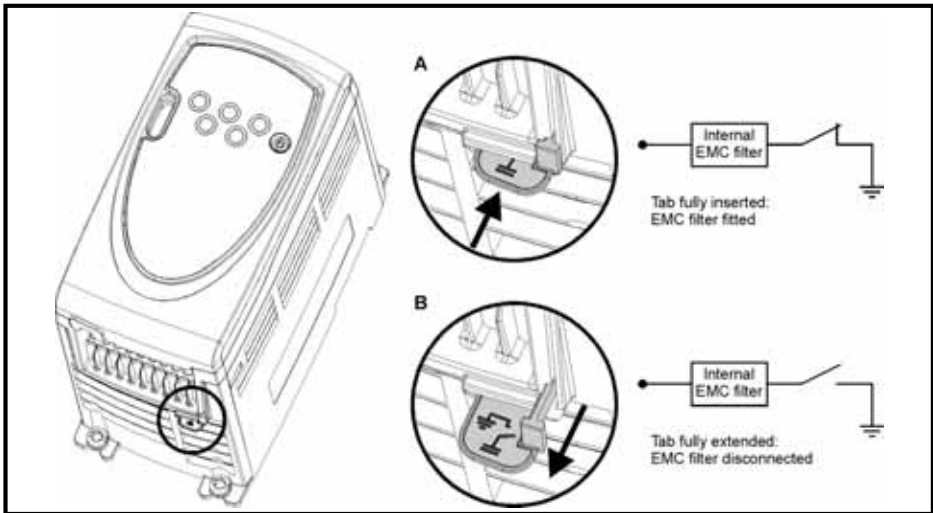



### 4.3.3 Further EMC precautions

Further EMC precautions are required if more stringent EMC emission requirements apply:

- Operation in the first environment of EN 61800-3:2004
- Conformity to the generic emission standards
- Equipment which is sensitive to electrical interference operating nearby

In this case it is necessary to use:

- The optional external EMC filter
- A shielded motor cable, with shield clamped to the grounded metal panel
- A shielded control cable, with shield clamped to the grounded metal panel

Full instructions are given in the *Digidrive SK Technical Data Guide*.

A full range of external EMC filters is also available for use with Digidrive SK.

## 4.4 Control terminals I/O specification



The control circuits are isolated from the power circuits in the drive by basic insulation (single insulation) only. The installer must ensure that the external control circuits are insulated from human contact by at least one layer of insulation (supplementary insulation) rated for use at the AC supply voltage.



If the control circuits are to be connected to other circuits classified as Safety Extra Low Voltage (SELV) (e.g. to personal computer), an additional isolating barrier must be included in order to maintain the SELV classification.



The above warnings also apply to the PCB edge connector for the optional Solutions Modules. To allow a Solutions Module to be installed with a Digidrive SK, a protective cover must be removed to allow access to the PCB edge connector. See Figure 3-5 on page 12. This protective cover provides protection from direct contact of the PCB edge connector by the user. When this cover is removed and a Solutions Module installed, the Solutions Module provides the protection from direct contact by the user. If the Solutions Module is then removed, this PCB edge connector becomes exposed. The user is required to provide protection in this case, to protect against direct contact of this PCB edge connector.

#### NOTE

See Pr **05** on page 25 (*Drive configuration*) for terminal connection / set-up diagrams and details.

#### NOTE

The digital inputs are positive logic only.

#### NOTE

The analog inputs are unipolar. For information on a bipolar input, see the *Digidrive SK Advanced User Guide*.

**T1 0V common****T2 Analog input 1 (A1), either voltage or current (see Pr 16)**

Voltage / Current input	0 to 10V / mA as parameter range
Parameter range	4-20, 20-4, 0-20, 20-0, 4-.20, 20-.4, VoLt
Scaling	Input range automatically scaled to Pr 01 <i>Minimum set speed</i> / Pr 02 <i>Maximum set speed</i>
Input impedance	200Ω (current) / 100kΩ (voltage)
Resolution	0.1%

**0-20:** Current input 0 to 20mA (20mA full scale)

**20-0:** Current input 20 to 0mA (0mA full scale)

**4-20:** Current input 4 to 20mA with current loop loss (cL1) trip (20mA full scale)

**20-4:** Current input 20 to 4mA with current loop loss (cL1) trip (4mA full scale)

**4-.20:** Current input 4 to 20mA with no current loop loss (cL1) trip (20mA full scale)

**20-.4:** Current input 20 to 4mA with no current loop loss (cL1) trip (4mA full scale)

**VoLt:** 0 to 10V input

**T3 +10V reference output**

Maximum output current	5mA
------------------------	-----

**T4 Analog input 2 (A2), either voltage or digital input**

Voltage / Digital input	0 to +10V / 0 to +24V
Scaling (as voltage input)	Input range automatically scaled to Pr 01 <i>Minimum set speed</i> / Pr 02 <i>Maximum set speed</i>
Resolution	0.1%
Input impedance	100kΩ (voltage) / 6k8 (digital input)
Normal threshold voltage (as digital input)	+10V (positive logic only)

**T5 Status relay - Drive ok (Normally open)****T6**

Contact voltage rating	240Vac 30Vdc
Contact maximum current rating	2Aac 240V 4Adc 30V resistive load (2A 35Vdc for UL requirements). 0.3Adc 30V inductive load (L/R=40ms)
Contact minimum recommended rating	12V 100mA
Contact isolation	1.5kVac (over voltage category II)
Operation of contact (drive ok - default condition)	OPEN AC supply removed from drive AC supply applied to drive with drive in tripped condition CLOSED AC supply applied to drive with drive in a 'ready to run' or 'running' condition (not tripped)



Provide fuse or other over-current protection in status relay circuit.



A flyback diode should be installed across inductive loads connected to the status relay.

<b>B1 Analog voltage output - Motor speed</b>	
Voltage output	0 to +10V
Scaling	0V represents 0Hz/rpm output +10V represents the value in Pr <b>02 Maximum set speed</b>
Maximum output current	5mA
Resolution	0.1%

<b>B2 +24V output</b>	
Maximum output current	100mA

<b>B3 Digital output - Zero speed (or digital input)</b>	
Voltage range	0 to +24V
Maximum output current	50mA at +24V (current source)

**NOTE**

The total available current from the digital output plus the +24V output is 100mA. Terminal B3 can also be configured as a digital input, frequency output or PWM output. Refer to the *Digidrive SK Advanced User Guide* for more information.

<b>B4 Digital Input - Enable/Reset**/**</b>	
<b>B5 Digital Input - Run Forward**</b>	
<b>B6 Digital Input - Run Reverse**</b>	
<b>B7 Digital Input - Local/Remote speed reference select (A1/A2)</b>	
Logic	Positive logic only
Voltage range	0 to +24V
Nominal threshold voltage	+10V

Terminal B7 can also be configured as a thermistor input or frequency input. Refer to the *Digidrive SK Advanced User Guide* for more information

If the enable terminal is opened, the drive's output is disabled and the motor will coast to a stop. The drive will not re-enable for 1.0s after the enable terminal is closed again.

\* Following a drive trip, opening and closing the enable terminal will reset the drive. If the run forward or run reverse terminal is closed, the drive will run straight away.

\*\* Following a drive trip and a reset via the stop/reset key, the enable, run forward or run reverse terminals will need to be opened and closed to allow the drive to run. This ensures that the drive does not run when the stop/reset key is pressed.

The enable, run forward and run reverse terminals are level triggered apart from after a trip where they become edge triggered. See \* and \*\* above.

If the enable and run forward or enable and run reverse terminals are closed when the drive is powered up, the drive will run straight away up to a set speed.

If both the run forward and run reverse terminals are closed, the drive will stop under the control of the ramp and stopping modes set in Pr **30** and Pr **31**.

---

## 5 Keypad and display

---

The keypad and display are used for the following:

- Displaying the operating status of the drive
- Displaying a fault or trip code
- Reading and changing parameter values
- Stopping, starting and resetting the drive

**Figure 5-1 Keypad and display**



**II** on the display indicates if motor map 1 or 2 is selected.

### 5.1 Programming keys

The **M** **MODE** key is used to change the mode of operation of the drive.

The **A** **UP** and **V** **DOWN** keys are used to select parameters and edit their values. In keypad mode, they are used to increase and decrease the speed of the motor.

### 5.2 Control keys

The **I** **START** key is used to start the drive in keypad mode.

The **STOP/RESET** key is used to stop and reset the drive in keypad mode. It can also be used to reset the drive in terminal mode.

**NOTE**

With USA defaults, the **STOP/RESET** key will be enabled.

**NOTE**

It is possible to change parameter values more quickly. See the *Digidrive SK Advanced User Guide* for details.

### 5.3 Selecting and changing parameters

**NOTE**

This procedure is written from the first power up of the drive and assumes no terminals have been connected, no parameters have been changed and no security has been set.

Figure 5-2

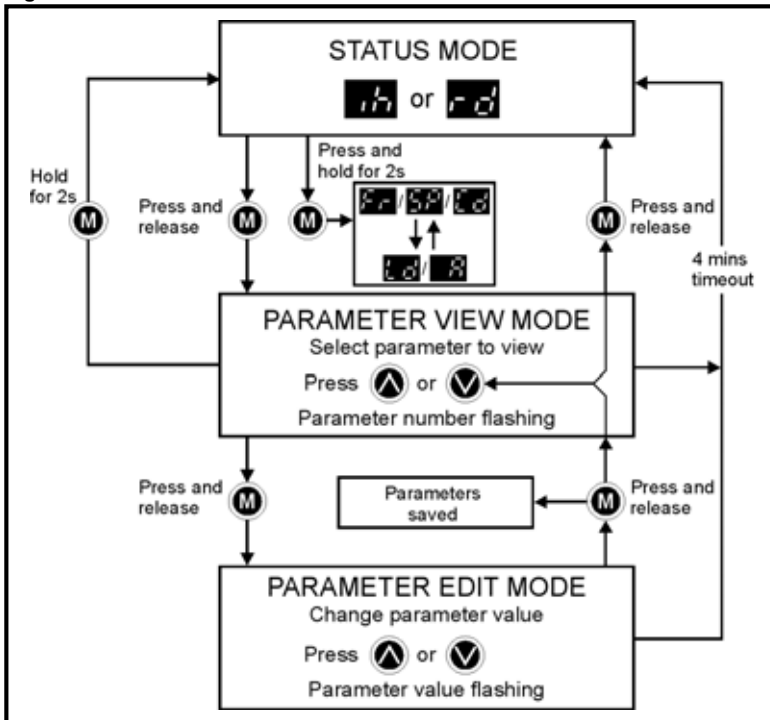





When in Status mode, pressing and holding the **M** MODE key for 2 seconds will change the display from displaying a speed indication to displaying load indication and vice versa.

Pressing and releasing the **M** MODE key will change the display from status mode to parameter view mode. In parameter view mode, the left hand display flashes the parameter number and the right hand display shows the value of that parameter.



Pressing and releasing the **M** MODE key again will change the display from parameter view mode to parameter edit mode. In parameter edit mode, the right hand display flashes the value in the parameter being shown in the left hand display.

Pressing the **M** MODE key in parameter edit mode will return the drive to the parameter view mode. If the **M** MODE key is pressed again then the drive will return to status mode, but if either of the ▲ up or ▼ down keys are pressed to change the parameter being viewed before the **M** MODE key is pressed, pressing the **M** MODE key will change the display to the parameter edit mode again. This allows the user to very easily change between parameter view and edit modes while commissioning the drive.



## Status Modes

Left hand display	Status	Explanation
	Drive ready	The drive is enabled and ready for a start command. The output bridge is inactive.
	Drive inhibited	The drive is inhibited because there is no enable command, or a coast to stop is in progress or the drive is inhibited during a trip reset.
	Drive has tripped	The drive has tripped. The trip code will be displayed in the right hand display.
	DC injection braking	DC injection braking current is being applied to the motor.
	Mains loss	See the <i>Digidrive SK Advanced User Guide</i> .

## Speed Indications

Display Mnemonic	Explanation
	Drive output frequency in Hz
	Motor speed in rpm
	Machine speed in customer define units

## Load indications

Display Mnemonic	Explanation
	Load current as a% of motor rated load current
	Drive output current per phase in Amps

## 5.4 Saving parameters

Parameters are automatically saved when the **M** MODE key is pressed when going from parameter edit mode to parameter view mode.

**NOTE** Parameters Pr **61** to Pr **80** are only stored by holding down the **STOP/RESET** key for 2 s.

## 5.5 Parameter access

There are 3 levels of parameter access controlled by Pr **10**. This determines which parameters are accessible. See Table 5-1.

The setting of the user security Pr **25** determines whether the parameter access is read only (RO) or read write (RW).

Table 5-1

Parameter access (Pr 10)	Parameters accessible
L1	Pr <b>01</b> to Pr <b>10</b>
L2	Pr <b>01</b> to Pr <b>60</b>
L3	Pr <b>01</b> to Pr <b>95</b>

## 5.6 Security codes

Setting a security code allows view only access to all parameters.

A security code is locked into the drive when Pr **25** is set to any other value than 0 and then **LoC** is selected in Pr **10**. On pressing the **M** MODE key, Pr **10** is automatically changed from **LoC** to **L1** and Pr **25** will be automatically set to 0 so as not to reveal the security code.

Pr **10** may be changed to L2 or L3 to allow view only access to parameters.

### 5.6.1 Setting a security code

- Set Pr **10** to L2.
- Set Pr **25** to the desired security code e.g. 5
- Set Pr **10** to LoC.
- Press the **M** MODE key
- Pr **10** will now be reset to L1 and Pr **25** will be reset to 0.
- The security code will now be locked into the drive.
- Security will also be set if the drive is powered down after a security code has been set into Pr **25**.

### 5.6.2 Unlocking a security code

- Select parameter to be edited
- Press the **M** MODE key, the right hand display will flash 'CodE'
- Press the **▲** UP key to start entering the set security code. The left hand display will show 'Co'
- Enter the correct security code
- Press the **M** MODE key
- If the correct security code has been entered, the right hand display will flash and can now be adjusted.
- If the security code has been entered incorrectly, the left hand display will flash the parameter number. The above procedure should be followed again.

### 5.6.3 Re-locking security

When a security code has been unlocked and the required parameter changes made, to re-lock the same security code:

- Set Pr **10** to LoC
- Press the **●** STOP/RESET key

### 5.6.4 Setting security back to 0 (zero) - no security

- Set Pr **10** to L2
- Go to Pr **25**
- Unlock security as described above.
- Set Pr **25** to 0
- Press the **M** MODE key.

**NOTE** If a security code has been lost or forgotten, please contact LEROY-SOMER.

## 5.7 Setting drive back to default values

- Set Pr **10** to L2
- Set Pr **29** to Eur and press the **M** MODE key. This loads 50Hz default parameters.  
or
- Set Pr **29** to USA and press the **M** MODE key. This loads 60Hz default parameters.

## 6 Parameters

Parameters are grouped together into appropriate subsets as follows:

### Level 1

Pr 01 to Pr 10: Basic drive set-up parameters

### Level 2

Pr 11 to Pr 12: Drive operation set-up parameters

Pr 15 to Pr 21: Reference parameters

Pr 22 to Pr 29: Display / keypad configuration

Pr 30 to Pr 33: System configuration

Pr 34 to Pr 36: Drive user I/O configuration

Pr 37 to Pr 42: Motor configuration (non-standard set-up)

Pr 43 to Pr 44: Serial communications configuration

Pr 45: Drive software version

Pr 46 to Pr 51: Mechanical brake configuration

Pr 52 to Pr 54: Fieldbus configuration

Pr 55 to Pr 58: Drive trip log

Pr 59 to Pr 60: PLC ladder programming configuration

Pr 61 to Pr 70: User definable parameter area

### Level 3

Pr 71 to Pr 80: User definable parameter set-up

Pr 81 to Pr 95: Drive diagnostics parameters

These parameters can be used to optimise the set-up of the drive for the application.

### 6.1 Parameter descriptions - Level 1

No	Function	Range	Defaults	Type
01	Minimum set speed	0 to Pr 02 Hz	0.0	RW

Used to set the minimum speed at which the motor will run in both directions.  
(0V reference or minimum scale current input represents the value in Pr 01)

No	Function	Range	Defaults	Type
02	Maximum set speed	0 to 1500 Hz	Eur: 50.0, USA: 60.0	RW

Used to set the maximum speed at which the motor will run in both directions.

If Pr 02 is set below Pr 01, Pr 01 will be automatically set to the value of Pr 02. (+10V reference or full scale current input represents the value in Pr 02)

#### NOTE

The output speed of the drive can exceed the value set in Pr 02 due to slip compensation and current limits.

No	Function	Range	Defaults	Type
03	Acceleration rate	0 to 3200.0 s/100Hz	Eur: 5.0, USA: 33	RW
04	Deceleration rate		Eur: 10.0, USA: 33	

Sets the acceleration and deceleration rate of the motor in both directions in seconds/100Hz.

#### NOTE

If one of the standard ramp modes is selected (see Pr 30 on page 34), the deceleration rate could be extended automatically by the drive to prevent over voltage (OV) trips if the load inertia is too high for the programmed deceleration rate.



No	Function	Range	Defaults	Type
05	Drive configuration	AI.AV, AV.Pr, AI.Pr, Pr, PAd, E.Pot, tor, Pid, HVAC	Eur: AI.AV, USA: PAd	RW

The setting of Pr 05 automatically sets up the drives configuration.

**NOTE** A change to Pr 05 is set by pressing the **M** MODE key on exit from parameter edit mode. The drive must be disabled, stopped or tripped for a change to take place. If Pr 05 is changed while the drive is running, when the **M** MODE key is pressed on exit from parameter edit mode, Pr 05 will change back to its previous value.

**NOTE** When the setting of Pr 05 is changed, the appropriate drive configuration parameters are set back to their default values.

For example, changing Pr 05 from AI.AV to PAd, means that Pr 11 would change to 0 (un-latched).

In all of the settings below, the status relay is set up as a drive ok relay:



Configuration	Description
AI.AV	Voltage and current input
AV.Pr	Voltage input and 3 preset speeds
AI.Pr	Current input and 3 preset speeds
Pr	4 preset speeds
PAd	Keypad control
E.Pot	Electronic motorized potentiometer control
tor	Torque control operation
Pid	PID control
HVAC	Fan and pump control

Figure 6-1 Pr 05 = AI.AV

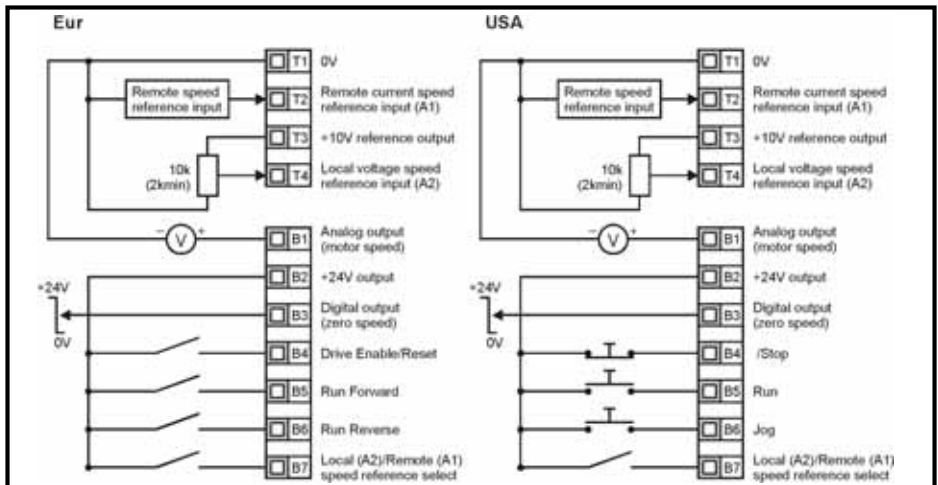

Terminal B7 open: Local voltage speed reference (A2) selected

Terminal B7 closed: Remote current speed reference (A1) selected

Figure 6-2 Pr 05 = AV.Pr

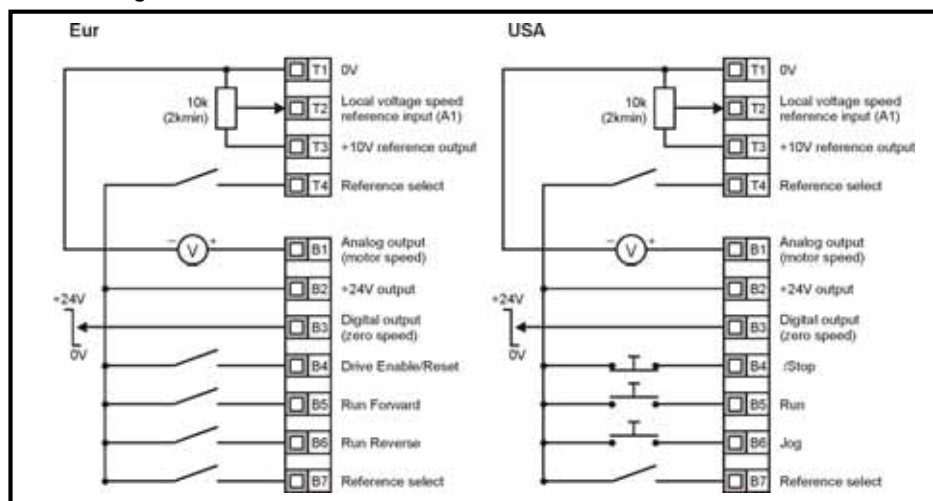

T4	B7	Reference selected
0	0	A1
0	1	Preset 2
1	0	Preset 3
1	1	Preset 4

Figure 6-3 Pr 05 = AI.Pr

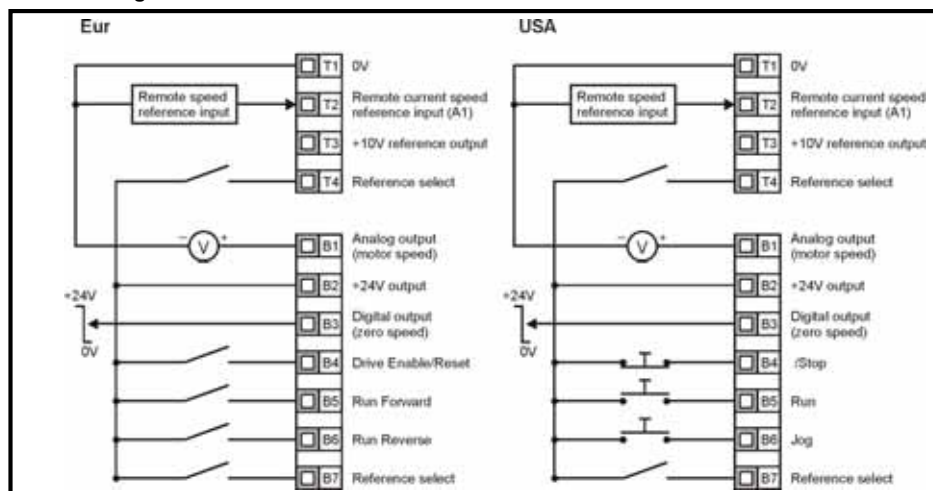

T4	B7	Reference selected
0	0	A1
0	1	Preset 2
1	0	Preset 3
1	1	Preset 4

Figure 6-4 Pr 05 = Pr

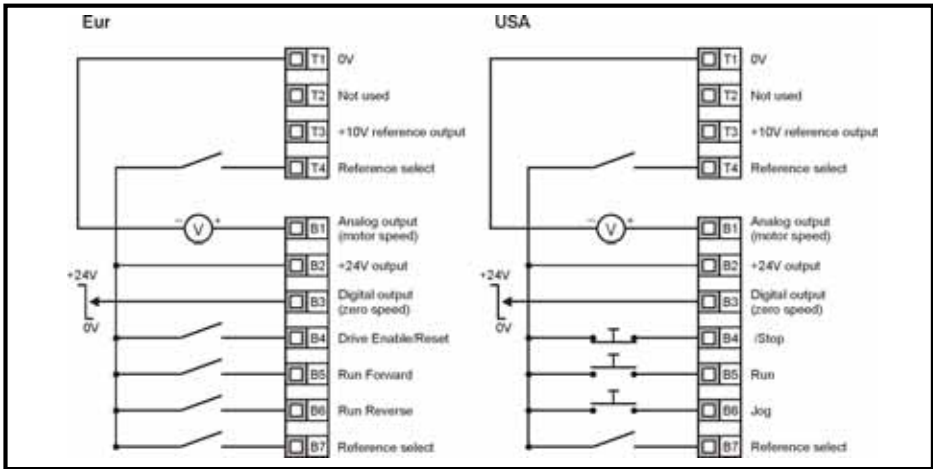

T4	B7	Reference selected
0	0	Preset 1
0	1	Preset 2
1	0	Preset 3
1	1	Preset 4

Figure 6-5 Pr 05 = PAD

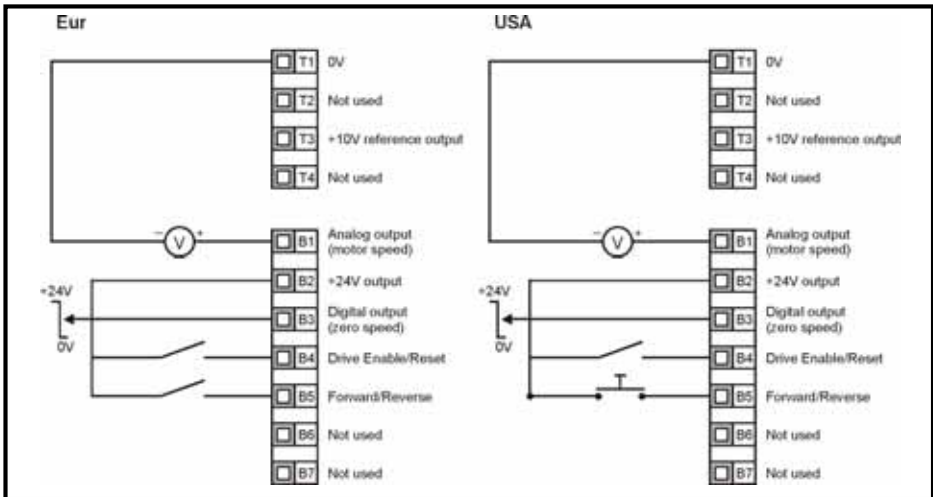

### Setting-up a Forward/Reverse terminal in Keypad mode

From the drive's display:

- Set Pr 71 to 8.23
- Set Pr 61 to 6.33
- Press the Stop/Reset key

Terminal B5 will now be set-up as a Forward/Reverse terminal

Figure 6-6 Pr 05 = E.Pot

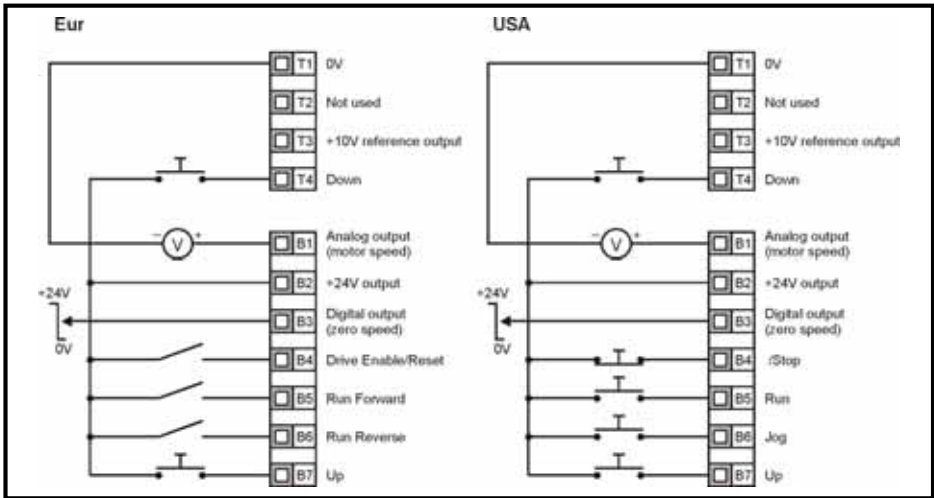

When Pr 05 is set to E.Pot, the following parameters are made available for adjustment:

- Pr 61: Motorized pot up/down rate (s/100%)
- Pr 62: Motorized pot bipolar select (0 = unipolar, 1 = bipolar)
- Pr 63: Motorized pot mode: 0 = zero at power-up, 1 = last value at power-up, 2 = zero at power-up and only change when drive is running, 3 = last value at power-up and only change when drive is running.

Figure 6-7 Pr 05 = tor

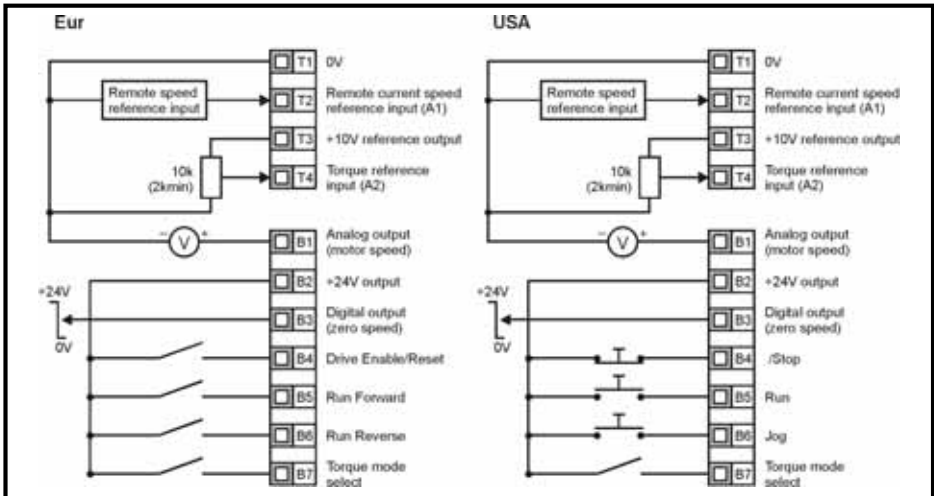

When torque mode is selected and the drive is connected to an unloaded motor, the motor speed may increase rapidly to the maximum speed (Pr 02 +20%)

Figure 6-8 Pr 05 = Pid

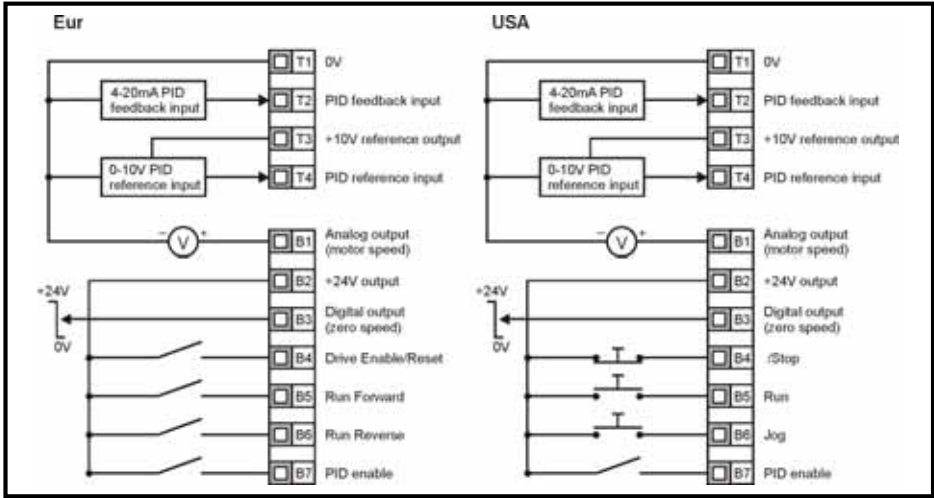

When Pr 05 is set to Pid, the following parameters are made available for adjustment:

- Pr 61: PID proportional gain
- Pr 62: PID integral gain
- Pr 63: PID feedback invert
- Pr 64: PID high limit (%)
- Pr 65: PID low limit (%)
- Pr 66: PID output (%)

Figure 6-9 PID logic diagram

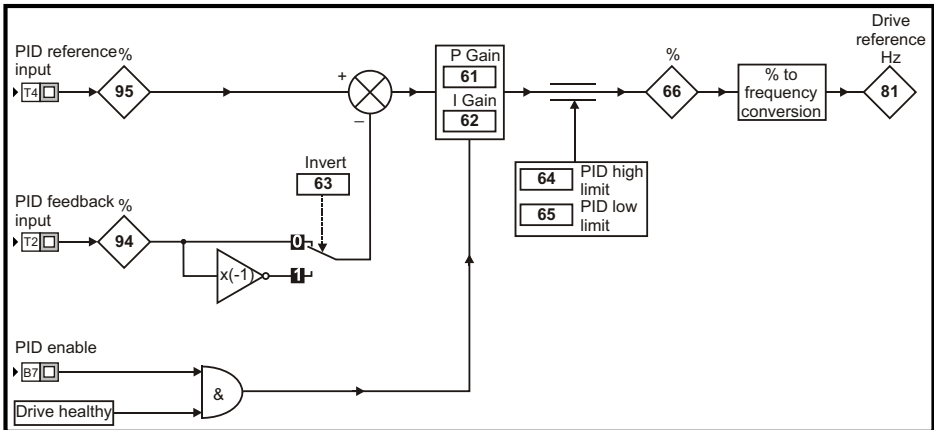
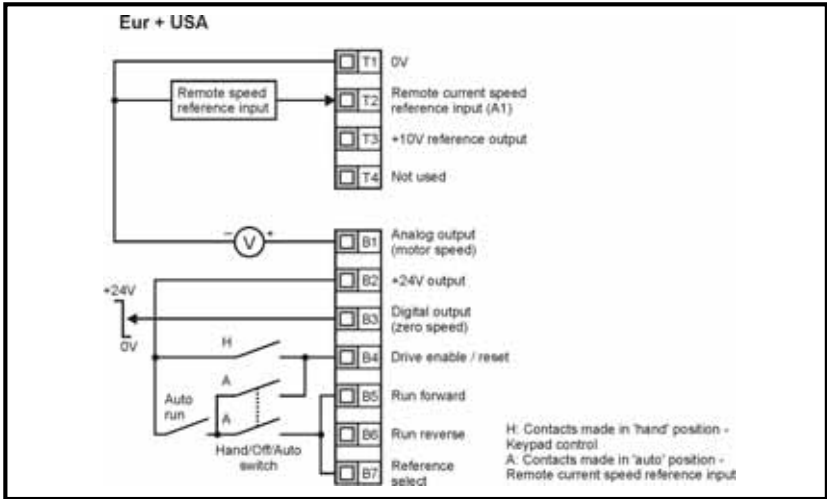

Figure 6-10 Pr 05 = HVAC terminal configuration



No	Function	Range	Defaults	Type
06	Motor rated current	0 to Drive rated current A	Drive rating	RW

Enter the motor current rating (taken from the motor name plate).

The drive rated current is the 100% RMS output current value of the drive. This value can be set to a lower value but not to a higher value than the drive rated current.



Pr 06 *Motor rated current* must be set correctly to avoid a risk of fire in the event of a motor overload.

No	Function	Range	Defaults	Type
07	Motor rated speed	0 to 9999 rpm	Eur: 1500, USA: 1800	RW

Enter the rated full load speed of the motor (taken from the motor name plate).

The motor rated speed is used to calculate the correct slip speed for the motor.

**NOTE** A value of zero entered into Pr 07 means slip compensation is disabled.

**NOTE** If the full load speed of the motor is above 9999rpm, enter a value of 0 in Pr 07. This will disable slip compensation as values >9999 cannot be entered into this parameter.

**NOTE** Slip compensation should be disabled when using the drive on a high inertia load.

No	Function	Range	Defaults	Type
08	Motor rated voltage	0 to 240, 0 to 480 V	Eur: 230 / 400 USA: 230 / 460	RW

Enter the motor rated voltage (taken from the motor name plate).

This is the voltage applied to the motor at base frequency.

**NOTE** If the motor is not a standard 50 or 60Hz motor, see Pr 39 on page 37 and adjust accordingly.

No	Function	Range	Defaults	Type
09	Motor power factor	0 to 1	0.85	RW

Enter the motor rated power factor  $\cos \varphi$  (taken from the motor name plate).

**NOTE** The power factor value could be automatically changed after a rotating autotune. See Pr 38 on page 36.

No	Function	Range	Defaults	Type
10	Parameter access	L1, L2, L3, LoC	L1	RW

**L1:** Level 1 access - only the first 10 parameters can be accessed

**L2:** Level 2 access - All parameters from 01 to 60 can be accessed

**L3:** Level 3 access - All parameters from 01 to 95 can be accessed

**LoC:** Used to lock a security code in the drive. See section 5.6 *Security codes* on page 23 for further details.

## 6.2 Parameter descriptions - Level 2

No	Function	Range	Defaults	Type
11	Start/Stop logic select	0 to 6	Eur: 0, USA: 4	RW

Pr 11	Terminal B4	Terminal B5	Terminal B6	Latching
0	Enable	Run Forward	Run Reverse	No
1	/Stop	Run Forward	Run Reverse	Yes
2	Enable	Run	Forward / Reverse	No
3	/Stop	Run	Forward / Reverse	Yes
4	/Stop	Run	Jog*	Yes
5	User programmable	Run Forward	Run Reverse	No
6	User Programmable	User Programmable	User Programmable	User Programmable

\*Jog can be used without the /Stop being active.

**NOTE** A change to Pr 11 is set by pressing the **M** MODE key on exit from parameter edit mode. The drive must be disabled, stopped or tripped for a change to take place. If Pr 11 is changed while the drive is running, when the **M** MODE key is pressed on exit from parameter edit mode, Pr 11 will change back to its previous value.

No	Function	Range	Defaults	Type
12	Brake controller enable	diS, rEL, d IO, USEr	diS	RW

**diS:** Mechanical brake software disabled

**rEL:** Mechanical brake software enabled. Brake control via relay T5 & T6. The digital output on terminal B3 is automatically programmed as a drive ok output.

**d IO:** Mechanical brake software enabled. Brake control via digital output B3. The relay outputs on terminals T5 and T6 are automatically programmed as a drive ok output.

**USEr:** Mechanical brake software enabled. Brake control to be programmed by user. The relay and digital output are not programmed. The user should programme the brake control to either the digital output or relay. The output not programmed to the brake control can be programmed to indicate the required signal. (See *Digidrive SK Advanced User Guide*.)

**NOTE** A change to Pr 12 is set by pressing the **M** MODE key on exit from parameter edit mode. The drive must be disabled, stopped or tripped for a change to take place. If Pr 12 is changed while the drive is running, when the **M** MODE key is pressed on exit from parameter edit mode, Pr 12 will change back to its previous value.

See Pr 46 to Pr 51 on page 38.



Great care should be taken when implementing a brake control set-up, as this may cause a safety issue depending on the application, e.g. crane. If in doubt, contact the supplier of the drive for further information.



Ensure that the brake controller is set-up correctly before the electro-mechanical brake circuit is connected to the drive. Disconnect the electro-mechanical brake circuit before a default is performed.

No	Function	Range	Defaults	Type
13	Not used			
14				

No	Function	Range	Defaults	Type
15	Jog reference	0 to 400.0 Hz	1.5	RW

Defines the jog speed

No	Function	Range	Defaults	Type
16	Analog input 1 mode	0-20, 20-0, 4-20, 20-4, 4-20, 20-4, VoLt	4-20	RW

Determines the input on terminal T2

**0-20:** Current input 0 to 20mA (20mA full scale)

**20-0:** Current input 20 to 0mA (0mA full scale)

**4-20:** Current input 4 to 20mA with current loop loss (cL1) trip (20mA full scale)

**20-4:** Current input 20 to 4mA with current loop loss (cL1) trip (4mA full scale)

**4-20:** Current input 4 to 20mA with no current loop loss (cL1) trip (20mA full scale)

**20-4:** Current input 20 to 4mA with no current loop loss (cL1) trip (4mA full scale)

**VoLt:** 0 to 10V input

**NOTE**

In the 4-20 or 20-4mA modes (with current loop loss) the drive will trip on cL1 if the input reference is below 3mA. Also, if the drive trips on cL1, the voltage analog input cannot be selected.

**NOTE**

If both analog inputs (A1 and A2) are to be set-up as voltage inputs, and if the potentiometers are supplied from the drive's +10V rail (terminal T3), they must have a resistance >4kΩ each.

No	Function	Range	Defaults	Type
17	Enable negative preset speeds	OFF or On	OFF	RW

**OFF:** Direction of rotation controlled by run forward and run reverse terminals

**On:** Direction of rotation controlled by preset speed values (use run forward terminal) or keypad reference.



No	Function	Range	Defaults	Type
18	Preset speed 1	±1500 Hz (Limited by setting of Pr 02 <i>Maximum set speed</i> )	0.0	RW
19	Preset speed 2			
20	Preset speed 3			
21	Preset speed 4			

Defines preset speeds 1 to 4.

No	Function	Range	Defaults	Type
22	Load display units	Ld, A	Ld	RW

**Ld:** Active current as a % of motor rated active current

**A:** Drive output current per phase in Amps

No	Function	Range	Defaults	Type
23	Speed display units	Fr, SP, Cd	Fr	RW

**Fr:** Drive output frequency in Hz

**SP:** Motor speed in rpm

**Cd:** Machine speed in customer defined units (See Pr 24).

No	Function	Range	Defaults	Type
24	Customer defined scaling	0 to 9.999	1.000	RW

Multiplying factor on motor speed (rpm) to give customer defined units.

No	Function	Range	Defaults	Type
25	User security code	0 to 999	0	RW

Used to set-up a user security code. See section 5.6 *Security codes* on page 23.

No	Function	Range	Defaults	Type
26	Not used			

No	Function	Range	Defaults	Type
27	Power up keypad reference	0, LAST, PrS1	0	RW

**0:** keypad reference is zero

**LAST:** keypad reference is last value selected before the drive was powered down

**PrS1:** keypad reference is copied from preset speed 1

No	Function	Range	Defaults	Type
28	Parameter copying	no, rEAd, Prog, boot	no	RW

**no:** no action

**rEAd:** program the drive with the contents of the SmartStick

**Prog:** program the SmartStick with the current drive settings

**boot:** SmartStick becomes read only. The contents of the SmartStick will be copied to the drive every time the drive is powered up.

**NOTE**

Before setting boot mode, the current drive settings must be stored in the SmartStick by using Prog mode, otherwise the drive will trip on C.Acc at power-up.

When boot mode is enabled, it is impossible to return to rEAd or Prog mode. To disable this mode, please get in touch with your usual LEROY-SOMER contact.

Parameter copying is initiated by pressing the **M** MODE key on exit from parameter edit mode after Pr 28 has been set to rEAd, Prog or boot.

**NOTE** If parameter copying is enabled when no SmartStick is installed to the drive, the drive will trip on C.Acc.

**NOTE** The SmartStick can be used to copy parameters between drives of different ratings. Certain drive dependant parameters will be stored on the SmartStick but will not be copied to the cloned drive.

The drive will trip on C.rtg when being written to by a copied parameter set of a different drive rating.

The drive dependant parameters are: Pr **06** Motor rated current, Pr **08** Motor rated voltage, Pr **09** Motor power factor and Pr **37** Maximum switching frequency.

**NOTE** Before the SmartStick /LogicStick is written to using Prog, the SmartStick/LogicStick will need to be inserted into the drive at power up or a reset command performed when the drive has been powered up, otherwise will trip on C.dAt when Prog command executed.

**NOTE** For best motor performance, an autotune should be carried out after parameter copying has taken place.

**NOTE** When copying between drives of different ratings, bit parameters will not be copied.

No	Function	Range	Defaults	Type
<b>29</b>	Load defaults	no, Eur, USA	no	RW

**no:** defaults are not loaded

**Eur:** 50Hz default parameters are loaded

**USA:** 60Hz default parameters are loaded

Default parameters are set by pressing the **M** MODE key on exit from parameter edit mode after Pr **29** has been set to Eur or USA.

When default parameters have been set, the display will return to Pr **01** and Pr **10** will be reset to L1.

**NOTE** The drive must be in a disabled, stopped or tripped condition to allow default parameters to be set. If default parameters are set while the drive is running, the display will flash FAIL once before changing back to no.



Disconnect the electro-mechanical brake circuit before a default is performed.

No	Function	Range	Defaults	Type
<b>30</b>	Ramp mode select	0 to 3	1	RW

**0:** Fast ramp selected

**1:** Standard ramp with normal motor voltage selected

**2:** Standard ramp with high motor voltage selected

**3:** Fast ramp with high motor voltage selected

Fast ramp is linear deceleration at programmed rate, normally used when a braking resistor is installed.

Standard ramp is controlled deceleration to prevent DC bus over-voltage trips, normally used when there is no braking resistor installed.

If a high motor voltage mode is selected, deceleration rates can be faster for a given inertia but motor temperatures will be higher.

No	Function	Range	Defaults	Type
<b>31</b>	Stop mode select	0 to 4	1	RW

- 0: Coast to stop selected
- 1: Ramp to stop selected
- 2: Ramp to stop with 1 second DC injection braking
- 3: DC injection braking with detection of zero speed
- 4: Timed DC injection braking

See the *Digidrive SK Advanced User Guide*.

No	Function	Range	Defaults	Type
<b>32</b>	Dynamic V to f select	OFF or On	OFF	RW

**OFF:** Fixed linear voltage to frequency ratio (constant torque - standard load)

**On:** Voltage to frequency ratio dependant on load current. This gives a higher motor efficiency.

No	Function	Range	Defaults	Type
<b>33</b>	Catch a spinning motor select	0 to 3	0	RW

- 0: Disabled
- 1: Detect positive and negative frequencies
- 2: Detect positive frequencies only
- 3: Detect negative frequencies only

If the drive is to be configured in fixed boost mode (Pr **41** = Fd or SrE) with catch a spinning motor software enabled, an autotune (see Pr **38** on page 36) must be carried out to measure the motor's stator resistance beforehand. If a stator resistance is not measured, the drive may trip on OV or OI.AC while trying to catch a spinning motor.

No	Function	Range	Defaults	Type
<b>34</b>	Terminal B7 mode select	dig, th, Fr, Fr.hr	dig	RW

**dig:** Digital input

**th:** Motor thermistor input, connect as per diagram below

**Fr:** Frequency input. See *Digidrive SK Advanced User Guide*.

**Fr.hr:** High resolution frequency input. See *Digidrive SK Advanced User Guide*.

**Figure 6-11**

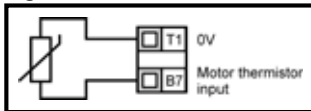

Trip resistance: 3k $\Omega$

Reset resistance: 1k $\Omega$

**NOTE**

If Pr **34** is set to th so that terminal B7 is used as a motor thermistor, the functionality of terminal B7 as set-up with Pr **05**, drive configuration, will be disabled.

When setting to th, press mode four times. Analog reference 2 will no longer be selected as the speed reference. Analog reference 1 should be used.

No	Function	Range	Defaults	Type
35	Digital output control (terminal B3)	n=0, At.SP, Lo.SP, hEAL, Act, ALAr, I.Lt, At.Ld, USEr	n=0	RW

**n=0:** At zero speed  
**At.SP:** At speed  
**Lo.SP:** At minimum speed  
**hEAL:** Drive ok  
**Act:** Drive active  
**ALAr:** General drive alarm  
**I.Lt:** Current limit active  
**At.Ld:** At 100% load  
**USEr:** User programmable

**NOTE** This parameter is automatically changed by the setting of Pr 12. When Pr 12 automatically controls the setting of this parameter, this parameter cannot be changed.

**NOTE** A change to Pr 35 is set by pressing the **M** MODE key on exit from parameter edit mode. See the *Digidrive SK Advanced User Guide*.

**NOTE** Terminal B3 can also be configured as a digital input, frequency output or PWM output. Refer to the *Digidrive SK Advanced User Guide* for more information.

No	Function	Range	Defaults	Type
36	Analog output control (terminal B1)	Fr, Ld, A, Por, USEr	Fr	RW

**Fr:** Voltage proportional to motor speed  
**Ld:** Voltage proportional to motor load  
**A:** Voltage proportional to output current  
**Por:** Voltage proportional to output power  
**USEr:** User programmable

**NOTE** A change to Pr 36 is set by pressing the **M** MODE key on exit from parameter edit mode. See the *Digidrive SK Advanced User Guide*.

No	Function	Range	Defaults	Type
37	Maximum switching frequency	3, 6, 12, 18 kHz	3	RW

**3:** 3kHz  
**6:** 6kHz  
**12:** 12kHz  
**18:** 18kHz

See the *Digidrive SK Technical Data Guide* for drive derating data.

**NOTE** 18kHz is not available on Digidrive SK size B, C and D 400V units and size D 200V units.

**NOTE** With drive firmware V01.07.01 onwards, the 400V size C drive will have an actual switching frequency of 3kHz when the output frequency is below 6Hz.

No	Function	Range	Defaults	Type
38	Autotune	0 to 2	0	RW

**0:** No autotune  
**1:** Non-rotating static autotune  
**2:** Rotating autotune



When a rotating autotune is selected, the drive will accelerate the motor up to  $\frac{2}{3}$  maximum speed in Pr **02**. Once a rotating autotune has been initiated (Pr **38** set to 2) on Digidrive SK, it must be completed before the drive will operate normally. If the rotating auto-tune is not completed (through the drive being disabled or a trip occurring), the drive will only run at the autotune speed ( $\frac{2}{3}$  rated speed reference) when the drive is asked to run again.

**NOTE** The motor must be at a standstill before a non-rotating autotune is initiated.

**NOTE** The motor must be at a standstill and unloaded before a rotating autotune is initiated.

No	Function	Range	Defaults	Type
<b>39</b>	Motor rated frequency	0.0 to 1500.0 Hz	Eur: 50.0, USA: 60.0	RW

Enter the motor rated frequency (taken from the motor name plate).

Defines the voltage to frequency ratio applied to the motor.

No	Function	Range	Defaults	Type
<b>40</b>	Number of motor poles	Auto, 2P, 4P, 6P, 8P	Auto	RW

**Auto:** Automatically calculates the number of motor poles from the settings of Pr **07** and Pr **39**

**2P:** Set for a 2 pole motor

**4P:** Set for a 4 pole motor

**6P:** Set for a 6 pole motor

**8P:** Set for an 8 pole motor

No	Function	Range	Defaults	Type
<b>41</b>	Voltage mode select	Ur S, Ur, Fd, Ur A, Ur I, SrE	Eur: Ur I, USA: Fd	RW

**Ur S:** Stator resistance is measured each time the drive is enabled and run

**Ur:** No measurement is taken

**Fd:** Fixed boost

**Ur A:** Stator resistance is measured the first time the drive is enabled and run

**Ur I:** Stator resistance measured at each power-up when the drive is enabled and run

**SrE:** Square law characteristic

In all Ur modes, the drive operates in open loop vector mode.

**NOTE** The drive default setting is Ur I mode which means that the drive will carry out an autotune every time the drive is powered-up and enabled. If the load is not going to be stationary when the drive is powered-up and enabled, then one of the other modes should be selected. Not selecting another mode could result in poor motor performance or OI.AC, It.AC or OV trips.

No	Function	Range	Defaults	Type
<b>42</b>	Low frequency voltage boost	0.0 to 50.0 %	Eur: 3.0, USA: 1.0	RW

Determines the boost level when Pr **41** is set to Fd or SrE.

No	Function	Range	Defaults	Type
<b>43</b>	Serial communications baud rate	2.4, 4.8, 9.6, 19.2, 38.4	19.2	RW

**2.4:** 2400 baud  
**4.8:** 4800 baud  
**9.6:** 9600 baud  
**19.2:** 19200 baud  
**38.4:** 38400 baud

No	Function	Range	Defaults	Type
<b>44</b>	Serial comms address	0 to 247	1	RW

Defines the unique address for the drive for the serial interface.

No	Function	Range	Defaults	Type
<b>45</b>	Software version	1.00 to 99.99		RO

Indicates the version of software installed in the drive.

**Pr 46 to Pr 51 appear when Pr 12 is set to control a motor brake.**

No	Function	Range	Defaults	Type
<b>46</b>	Brake release current threshold	0 to 200 %	50	RW
<b>47</b>	Brake apply current threshold		10	

Defines the brake release and brake apply current thresholds as a % of motor current.  
 If the frequency is >Pr **48** and the current is >Pr **46**, the brake release sequence is started.  
 If the current is <Pr **47**, the brake is applied immediately.

No	Function	Range	Defaults	Type
<b>48</b>	Brake release frequency	0.0 to 20.0 Hz	1.0	RW
<b>49</b>	Brake apply frequency		2.0	

Defines the brake release and brake apply frequencies.  
 If the current is >Pr **46** and the frequency is > Pr **48**, the brake release sequence is started.  
 If the frequency is <Pr **49** and the drive has been commanded to stop, the brake is applied immediately.

No	Function	Range	Defaults	Type
<b>50</b>	Pre-brake release delay	0.0 to 25.0 s	1.0	RW

Defines the time between the frequency and load condition being met and the brake being released. The ramp is held during this time.

No	Function	Range	Defaults	Type
<b>51</b>	Post brake release delay	0.0 to 25.0 s	1.0	RW

Defines the time between the brake being released and the ramp hold being released.

 The brake control functions are provided to allow well co-ordinated operation of an external brake with the drive. While both hardware and software are designed to high standards of quality and robustness, they are not intended for use as safety functions, i.e. where a fault or failure would result in a risk of injury. In any application where the incorrect operation of the brake release mechanism could result in injury, independent protection devices of proven integrity must also be incorporated.

**Figure 6-12 Brake function diagram**

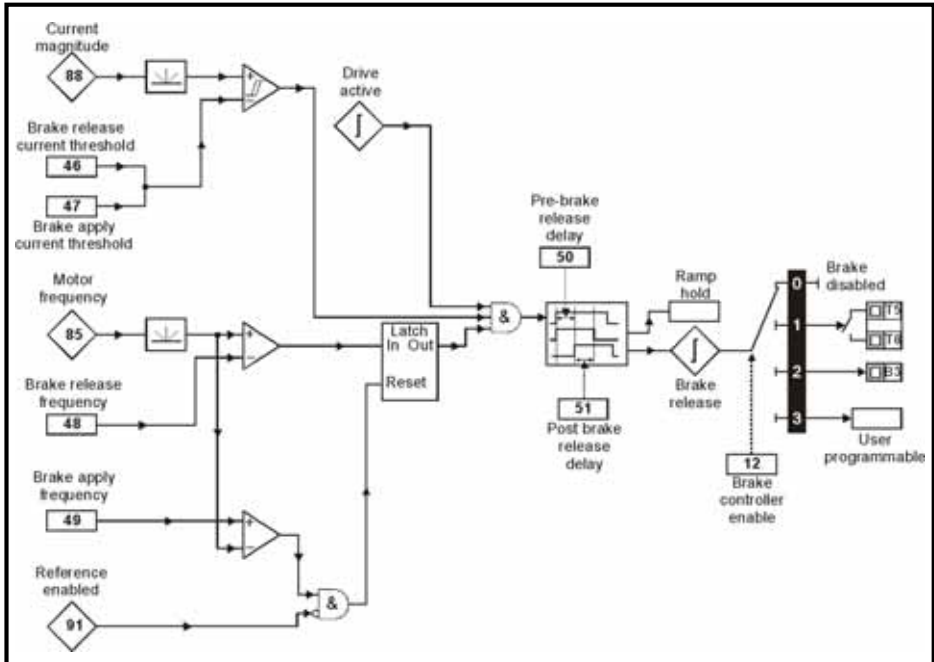

**Figure 6-13 Brake sequence**

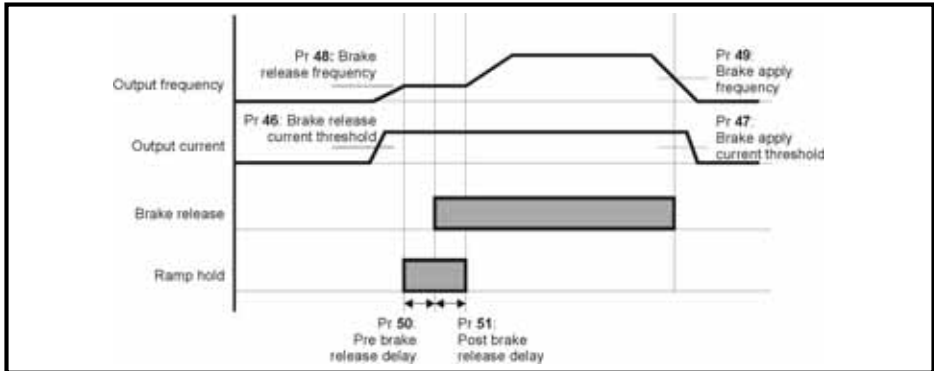

**Pr 52 to Pr 54 appear when a Solutions Module is installed in the drive.**

No	Function	Range	Defaults	Type
<b>52</b>	*Solutions Module dependant		0	RW

No	Function	Range	Defaults	Type
<b>53</b>	*Solutions Module dependant		0	RW

No	Function	Range	Defaults	Type
<b>54</b>	*Solutions Module dependant		0	RW

\*See the *Digidrive SK Advanced User Guide* for further information.

No	Function	Range	Defaults	Type
<b>55</b>	Last trip		0	RO
<b>56</b>	Trip before Pr <b>55</b>			
<b>57</b>	Trip before Pr <b>56</b>			
<b>58</b>	Trip before Pr <b>57</b>			

Indicates the last 4 trips of the drive.

No	Function	Range	Defaults	Type
<b>59</b>	PLC ladder program enable	0 to 2	0	RW

The PLC ladder program enable is used to start and stop the PLC ladder program.

**0:** Stop the PLC ladder program

**1:** Run the PLC ladder program (trip drive if LogicStick is not installed). Any out-of-range parameter writes attempted will be limited to the maximum/minimum values valid for that parameter before being written to.

**2:** Run the PLC ladder program (trip drive if LogicStick is not installed). Any out-of-range parameter writes attempted will cause the drive to trip.

See the *Digidrive SK Advanced User Guide* for details on PLC ladder programming.

No	Function	Range	Defaults	Type
<b>60</b>	PLC ladder program status	-128 to +127		RO

The PLC ladder program status parameter indicates the actual state of the PLC ladder program.

**-n:** PLC ladder program caused a drive trip due to an error condition while running rung n. Note that the rung number is shown on the display as a negative number.

**0:** LogicStick is installed with no PLC ladder program

**1:** LogicStick is installed, PLC ladder program is installed but stopped

**2:** LogicStick is installed, PLC ladder program is installed and running

**3:** LogicStick is not installed

No	Function	Range	Defaults	Type
<b>61 to 70</b>	Configurable parameter 1 to configurable parameter 10		As source	

Pr **61** to Pr **70** and Pr **71** to Pr **80** can be used to access and adjust advanced parameters.

**Example:** It is desired that Pr **1.29** (*Skip frequency 1*) is to be adjusted. Set one of the parameters Pr **71** to Pr **80** to 1.29, the value of Pr **1.29** will appear in the corresponding parameter from Pr **61** to Pr **70**. I.e. if Pr **71** is set to 1.29, Pr **61** will contain the value of Pr **1.29** where it can be adjusted.



**NOTE**

Some parameters are only implemented if the drive is disabled, stopped or tripped and the  STOP/RESET key is pressed for 1s.

See *Digidrive SK Advanced User Guide* for advanced parameter details.

## 6.3 Parameter descriptions - Level 3

No	Function	Range	Defaults	Type
<b>71 to 80</b>	Pr <b>61</b> to Pr <b>70</b> set up	0 to Pr <b>21.51</b>		RW

Set Pr **71** to Pr **80** to the required advanced parameter number to be accessed.

The value within these parameters will be displayed in Pr **61** to Pr **70**. Pr **61** to Pr **70** can then be adjusted to change the value within a parameter.

See *Digidrive SK Advanced User Guide* for further details.

## 6.4 Diagnostic parameters

The following read only (RO) parameters can be used as an aid to fault diagnosis on the drive. See Figure 8-1 *Diagnostics logic diagram* on page 48.

No	Function	Range	Type
<b>81</b>	Frequency reference selected	±Pr <b>02</b> Hz	RO
<b>82</b>	Pre-ramp reference	±Pr <b>02</b> Hz	RO
<b>83</b>	Post-ramp reference	±Pr <b>02</b> Hz	RO
<b>84</b>	DC bus voltage	0 to Drive maximum Vdc	RO
<b>85</b>	Motor frequency	±Pr <b>02</b> Hz	RO
<b>86</b>	Motor voltage	0 to Drive rating V	RO
<b>87</b>	Motor speed	±9999 rpm	RO
<b>88</b>	Motor current	+Drive maximum A	RO
<b>89</b>	Motor active current	±Drive maximum A	RO
<b>90</b>	Digital I/O read word	0 to 95	RO
<b>91</b>	Reference enabled indicator	OFF or On	RO
<b>92</b>	Reverse selected indicator	OFF or On	RO
<b>93</b>	Jog selected indicator	OFF or On	RO
<b>94</b>	Analog input 1 level	0 to 100 %	RO
<b>95</b>	Analog input 2 level	0 to 100 %	RO

# 7 Quick start commissioning

This procedure is written from default parameter settings as the drive would be delivered from the factory.



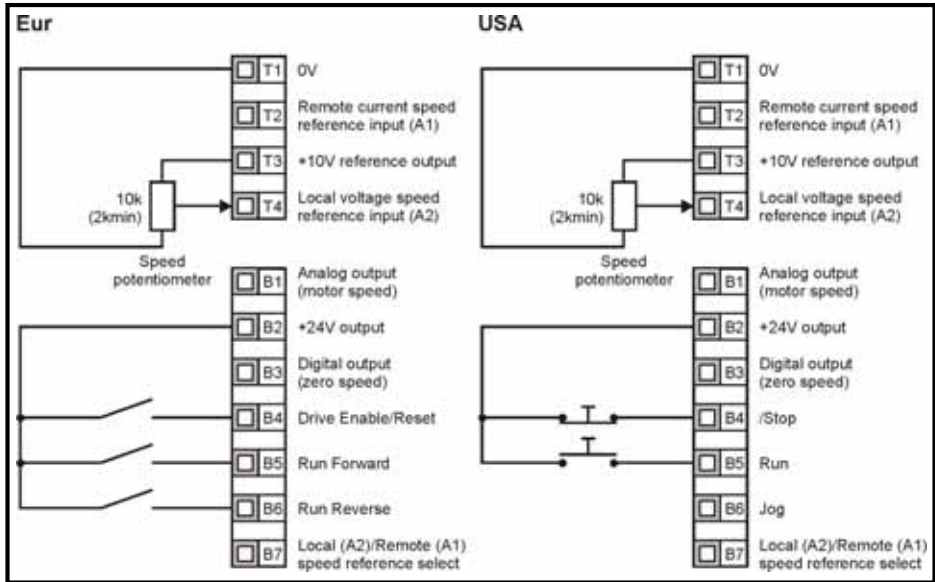

For European default settings refer to section 7.1 *Terminal control* . For USA default settings refer to section 7.2 *Keypad control* on page 44 .

## 7.1 Terminal control

Figure 7-1 Minimum required control terminal connections

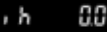

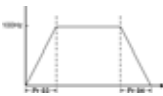
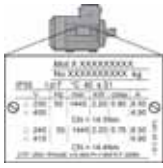
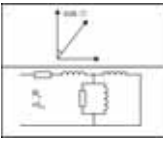
Terminal B7 open: Local voltage speed reference (A2) selected

Action	Detail	
Before power up	Ensure: <ul style="list-style-type: none"> <li>The drive enable signal is not given, terminal B4 is open</li> <li>The run signal is not given, terminal B5/B6 is open</li> <li>The motor is connected to the drive</li> <li>The motor connection is correct for the drive <math>\Delta</math> or Y</li> <li>The correct supply voltage is connected to the drive</li> </ul>	
Power up the drive	Ensure: <ul style="list-style-type: none"> <li>The drive displays: </li> </ul>	
Enter minimum and maximum speeds	Enter: <ul style="list-style-type: none"> <li>Minimum speed Pr <b>01</b> (Hz)</li> <li>Maximum speed Pr <b>02</b> (Hz)</li> </ul>	
Enter acceleration and deceleration rates	Enter: <ul style="list-style-type: none"> <li>Acceleration rate Pr <b>03</b> (s/100Hz)</li> <li>Deceleration rate Pr <b>04</b> (s/100Hz)</li> </ul>	
Enter motor nameplate details	Enter: <ul style="list-style-type: none"> <li>Motor rated current in Pr <b>06</b> (A)</li> <li>Motor rated speed in Pr <b>07</b> (rpm)</li> <li>Motor rated voltage in Pr <b>08</b> (V)</li> <li>Motor rated power factor in Pr <b>09</b></li> <li>If the motor is not a standard 50/60Hz motor, set Pr <b>39</b> accordingly</li> </ul>	
<b>Ready to autotune</b>		
Enable and run the drive	Close: <ul style="list-style-type: none"> <li>The Enable and Run Forward or Run Reverse signals</li> </ul>	
Autotune	The Digidrive SK will carry out a non-rotating autotune on the motor. The motor must be stationary to carry out an autotune correctly. The drive will carry out a non-rotating autotune every time it is first started after each power-up. If this will cause a problem for the application, set Pr <b>41</b> to the required value.	
Autotune complete	When the autotune has been completed, the display will show: 	
<b>Ready to run</b>		
Run	The drive is now ready to run the motor.	
Increasing and decreasing speed	Turning the speed potentiometer will increase and decrease the speed of the motor.	
Stopping	To stop the motor under ramp control, open either the run forward or run reverse terminal. If the enable terminal is opened while the motor is running, the motor will coast to a stop.	

Safety information
Rating data
Mechanical installation
Electrical installation
Keypad and display
Parameters
<b>Quick start commissioning</b>
Diagnostics
Options
UL listing information

## 7.2 Keypad control

Figure 7-2 Minimum required control terminal connections

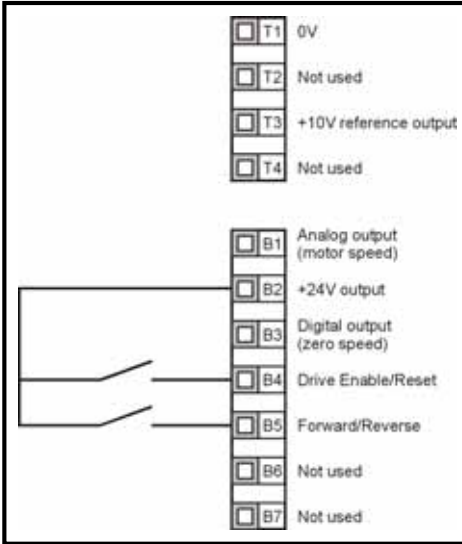

**NOTE** To implement a Forward/Reverse switch from the drive's display:

- Set Pr **71** to 8.23
- Set Pr **61** to 6.33
- Press the Stop/Reset key

Terminal B5 will now be set-up as a Forward/Reverse terminal

Action	Detail	
Before power up	Ensure: <ul style="list-style-type: none"> <li>The drive enable signal is not given, terminal B4 is open</li> <li>The motor is connected to the drive</li> <li>The motor connection is correct for the drive <math>\Delta</math> or Y</li> <li>The correct supply voltage is connected to the drive</li> </ul>	
Power up the drive	Ensure: <ul style="list-style-type: none"> <li>The drive displays: </li> </ul>	
Enter minimum and maximum speeds	Enter: <ul style="list-style-type: none"> <li>Minimum speed Pr <b>01</b> (Hz)</li> <li>Maximum speed Pr <b>02</b> (Hz)</li> </ul>	
Enter acceleration and deceleration rates	Enter: <ul style="list-style-type: none"> <li>Acceleration rate Pr <b>03</b> (s/100Hz)</li> <li>Deceleration rate Pr <b>04</b> (s/100Hz)</li> </ul>	
Set keypad control	Enter: <ul style="list-style-type: none"> <li><b>PAd</b> into Pr <b>05</b></li> </ul>	
Enter motor nameplate details	Enter: <ul style="list-style-type: none"> <li>Motor rated current in Pr <b>06</b> (A)</li> <li>Motor rated speed in Pr <b>07</b> (rpm)</li> <li>Motor rated voltage in Pr <b>08</b> (V)</li> <li>Motor rated power factor in Pr <b>09</b></li> <li>If the motor is not a standard 50/60Hz motor, set Pr <b>39</b> accordingly</li> </ul>	
<b>Ready to autotune</b>		
Enable and run the drive	Close: <ul style="list-style-type: none"> <li>The enable signal</li> <li>Press the  START key</li> </ul>	
Autotune	The Digidrive SK will carry out a non-rotating autotune on the motor. The motor must be stationary to carry out an autotune correctly. The drive will carry out a non-rotating autotune every time it is first started after each power-up. If this will cause a problem for the application, set Pr <b>41</b> to the required value.	
Autotune complete	When the autotune has been completed, the display will show:	
<b>Ready to run</b>		
Run	The drive is now ready to run the motor.	
Increasing and decreasing speed	Press the  UP key to increase the speed	
	Press the  DOWN key to decrease the speed	
Stopping	Press the  STOP/RESET key to stop the motor	

Safety information

Rating data

Mechanical installation

Electrical installation

Keypad and display

Parameters

Quick start commissioning

Diagnostics

Options

UL listing information

## 8 Diagnostics



Do not attempt to carry out internal repairs. Return a faulty drive to the supplier for repair.

Trip code	Condition	Possible cause
<b>UV</b>	DC bus under voltage	Low AC supply voltage Low DC bus voltage when supplied by an external DC power supply
<b>OV</b>	DC bus over voltage	Deceleration rate set too fast for the inertia of the machine Mechanical load driving the motor
<b>OI.AC**</b>	Drive output instantaneous over current	Insufficient ramp times Phase to phase or phase to ground short circuit on the drives output Drive requires autotuning to the motor Motor or motor connections changed, re-autotune drive to motor
<b>OI.br**</b>	Braking resistor instantaneous over current	Excessive braking current in braking resistor Braking resistor value too small
<b>O.SPd</b>	Over speed	Excessive motor speed (typically caused by mechanical load driving the motor)
<b>tunE</b>	Auto tune stopped before completion	Run command removed before autotune complete
<b>It.br</b>	$I^2t$ on braking resistor	Excessive braking resistor energy
<b>It.AC</b>	$I^2t$ on drive output current	Excessive mechanical load High impedance phase to phase or phase to ground short circuit at drive output Drive requires re-autotuning to motor
<b>O.ht1</b>	IGBT over heat based on drives thermal model	Overheat software thermal model
<b>O.ht2</b>	Over heat based on drives heatsink	Heatsink temperature exceeds allowable maximum
<b>th</b>	Motor thermistor trip	Excessive motor temperature
<b>O.Ld1*</b>	User +24V or digital output overload	Excessive load or short circuit on +24V output
<b>O.ht3</b>	Drive over-heat based on thermal model	Overheat software thermal model
<b>cL1</b>	Analog input 1 current mode, current loss	Input current less than 3mA when 4-20 or 20-4mA modes selected
<b>SCL</b>	Serial communications loss time-out	Loss of communication when drive is under remote control
<b>EEF</b>	Internal drive EEPROM trip	Possible loss of parameter values (set default parameters (see Pr 29 on page 34))
<b>PH</b>	Input phase imbalance or input phase loss	One of the input phases has become disconnected from the drive (applies to 200/400V three phase drives only, not dual rated drives)
<b>rS</b>	Failure to measure motors stator resistance	Motor too small for drive Motor cable disconnected during measurement
<b>CL.bt</b>	Trip initiated from the control word	Control word has initiated a trip
<b>O.ht4</b>	Power module rectifier over temperature	Power module rectifier temperature exceeds allowable maximum
<b>C.dAt</b>	SmartStick data does not exist	New/empty SmartStick being read. Reset the drive.
<b>C.Acc</b>	SmartStick read/write fail	Bad connection or faulty SmartStick
<b>C.rtg</b>	SmartStick/drive rating change	Already programmed SmartStick read by a drive of a different rating
<b>O.cL</b>	Overload on current loop input	Input current exceeds 25mA
<b>HFFx trip</b>	Hardware faults	Internal drive hardware fault (see <i>Digidrive SK Advanced User Guide</i> ).

\* The Enable/Reset terminal will not reset an O.Ld1 trip. Use the  Stop/Reset key.

\*\* These trips cannot be reset for 10 seconds after they occur.

See the *Digidrive SK Advanced User Guide* for further information on possible causes of drive trips.

**Table 8-1 DC bus voltages**

Drive voltage rating	UV Trip	UV Reset	Braking level	OV trip**
110V	175	215 *	390	415
200V	175	215 *	390	415
400V	330	425 *	780	830

**NOTE**

\* These are the absolute minimum DC voltages the drives can be supplied by.

\*\* The drive will trip on OV if the DC Bus goes above the OV trip level.

**Table 8-2 Alarm warnings/Display indications**

Display	Condition	Solution
<b>OVL.d</b>	I x t overload (I = current, t = time)	Reduce motor current (Load)
<b>hot</b>	Heatsink/IGBT temperature high	Reduce ambient temperature or reduce motor current
<b>br.rS</b>	Braking resistor overload	See Menu 10 in the <i>Digidrive SK Advanced User Guide</i>
<b>AC.Lt</b>	Drive is in current limit	See Menu 10 in the <i>Digidrive SK Advanced User Guide</i>
<b>FAIL</b>	Failed attempt to read stick	An attempt has been made to read the stick when the drive was not disabled or tripped, or the stick is read-only.

**NOTE**

If no action is taken when an alarm warning appears, the drive will trip on the appropriate fault code.

Safety information
Rating data
Mechanical installation
Electrical installation
Keypad and display
Parameters
Quick start commissioning
<b>Diagnostics</b>
Options
UL listing information

Figure 8-1 Diagnostics logic diagram

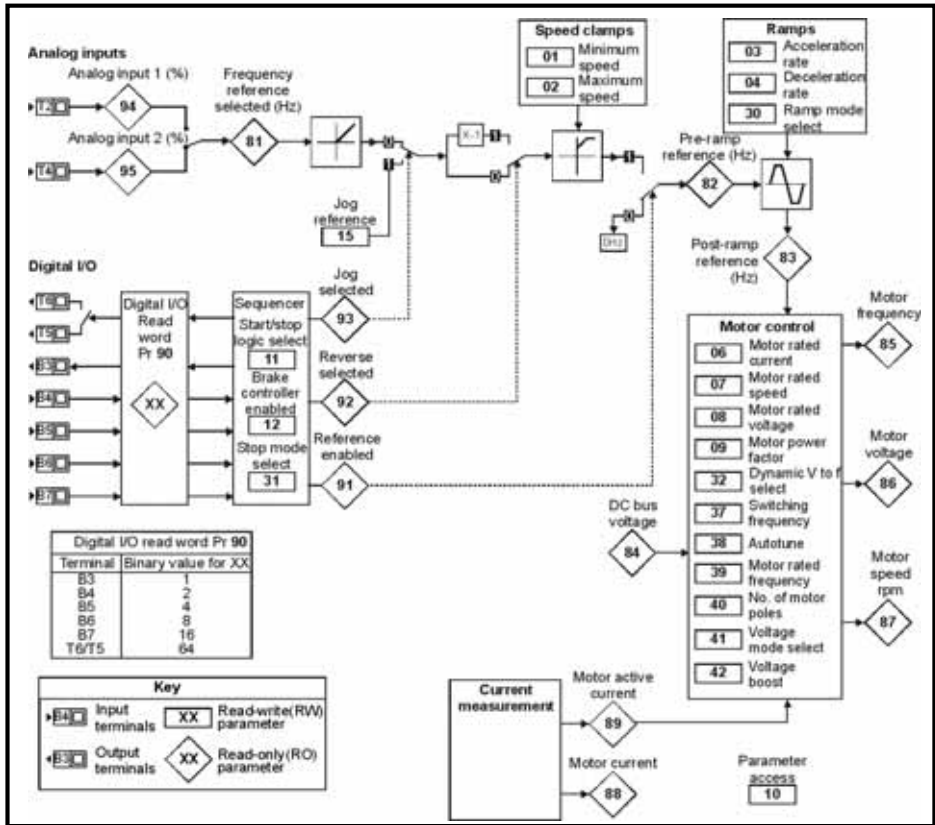

### Cooling fan control (size B, C and D only)











As default, the drive's cooling fan is controlled by the drive. The fan will remain off until the heatsink temperature reaches 60°C or the output current rises above 75% of the drive rating. The fan will then switch on and run at full speed for a minimum of 20s.

The cooling fan on a Digidrive SK size D is a dual speed fan. The drive controls the speed at which the fan runs based on the temperature of the drives heatsink and also the drive's thermal model system.





For further details, see the *Digidrive SK Advanced User Guide*.



# 9 Options

Option name	Function	Picture
SmartStick	Upload drive parameters to the SmartStick for storage or for easy set-up of identical drives or downloading to replacement drives	
LogicStick	The LogicStick plugs into the front of the drive and enables the user to program PLC functions within the drive The LogicStick can also be used as a SmartStick (now supplied with LogicStick Guard)	
LogicStick Guard Kitbag	The LogicStick guard protects the Logicstick when installed to a drive. Available in a bag of 25	
SM-I/O Lite*	Additional input/output module without real time clock	
SM-I/O Timer*	Additional input/output module with real time clock	
SM-I/O 120V*	Additional input/output module	
SM-I/O PELV*	Isolated input/output to NAMUR NE37 specifications (for chemical industry applications)	
SM-I/O 24V Protected*	Additional input/output module with overvoltage protection up to 48V. 2 x analog outputs, 4 x digital inputs/outputs, 3 x digital inputs, 1 x relay output	
SM-I/O 32*	Additional input/output module with 32 x digital inputs/outputs	
SM-PROFIBUS-DP-V1*	Fieldbus communications modules	
SM-DeviceNet*		
SM-CANopen*		
SM-INTERBUS*		
SM-Ethernet*		
SM-LON*		
SM-EtherCAT*		
SM-Keypad Plus	Remote panel mounting LCD multilingual text keypad display to IP54 (NEMA 12) with additional help key	
SK-Keypad Remote	Remote panel mounting LED display to IP65 (NEMA 12) with additional function key	
EMC filters	These additional filters are designed to operate together with the drive's own integral EMC filter in areas of sensitive equipment	
SK-Bracket	Cable management bracket	
Cover kit	The additional top cover kit will increase the environmental protection of the top face to IP4X in vertical direction.	
CT comms cable	Cable with isolation RS232 to RS485 converter. For connecting PC/Laptop to the drive when using LS SOFT or SyPTLite	

Safety information
Rating data
Mechanical installation
Electrical installation
Keypad and display
Parameters
Quick start commissioning
Diagnostics
<b>Options</b>
UL listing information

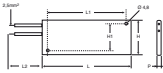
Option name	Function	Picture
CT USB comms cable	Cable with isolation RS232 to RS485 converter. For connecting PC/Laptop to the drive when using LS SOFT or SyPTLite	
AC input line reactors	To reduce supply harmonics	
LS SOFT	Software for PC or Laptop which allows the user to commission and store parameter settings	
SyPTLite	Software for PC or Laptop which allows the user to program PLC functions within the drive	
NEMA 1 + UL type 1 kit	Bottom metal gland plate, top cover and side covers to allow the drive to comply with the requirements of UL type 1	
Braking resistors	-	

\* Only applicable to sizes B, C and D

Details of all the above options can be found at [www.leroy-somer.com](http://www.leroy-somer.com).

## 9.1 Documentation

As well as the *Digidrive SK Getting Started Guide*, a number of other guides are available for Digidrive SK:

### ***Digidrive SK Technical Data Guide***

This gives all the technical data for the drive, such as:

- Fuse sizes
- Cable sizes
- Braking resistor information
- IP ratings
- Pollution degree
- Vibration specifications
- Humidity
- Altitude
- Weights
- Losses
- De-rating info
- EMC filter info

### ***Digidrive SK Advanced User Guide***

This gives detailed information on all of the drive's advanced parameters and also on the serial communications. Furthermore, it gives set-up examples for the drive.



### ***Option Module User Guides / Installation Sheets***

These guides provide detailed information and set-up instructions for the various options available for Digidrive SK.

All of these guides can be downloaded from [www.leroy-somer.com](http://www.leroy-somer.com).

# 10 UL listing information

Table 10-1 Approvals

	CE approval	Europe
	C Tick approval	Australia
	UL / cUL approval	USA & Canada

## 10.1 UL information (for Digidrive SK size A, B, C and D)

### 10.1.1 Conformity

The drive conforms to UL listing requirements only when the following are observed:

- Class 1 60/75°C (140/167°F) copper wire only is used in the installation
- The ambient temperature does not exceed 40°C (104°F) when the drive is operating
- The terminal tightening torques specified in section 4.1 *Power terminal connections* are used
- The drive is installed into a separate electrical enclosure. The drive has a UL 'Open type' enclosure rating.
- UL listed class CC fast acting fuses e.g. Bussman Limitron KTK series, Gould Amp-Trap ATM series or equivalent are used in the AC supply.

### 10.1.2 AC supply specification

The drive is suitable for use in a circuit capable of delivering not more than 100,000 RMS symmetrical Amperes at 264Vac RMS maximum (200V drives), 528Vac RMS maximum (400V drives) or 132Vac RMS (110V drives).

### 10.1.3 Motor overload protection

The drive provides motor overload protection. The overload protection level is 150% of full-load current. It is necessary for the motor rated current to be entered into Pr **06** for the protection to operate correctly. The protection level may be adjusted below 150% if required. Refer to the *Digidrive SK Advanced User Guide* for further information.

### 10.1.4 Overspeed protection

The drive provides overspeed protection. However, it does not provide the level of protection afforded by an independent high integrity overspeed protection device.

---

## Note

---

---

# Note

---

Safety information

Rating data

Mechanical installation

Electrical installation

Keypad and display

Parameters

Quick start commissioning

Diagnostics

Options

**UL listing information**

---

## Note

---



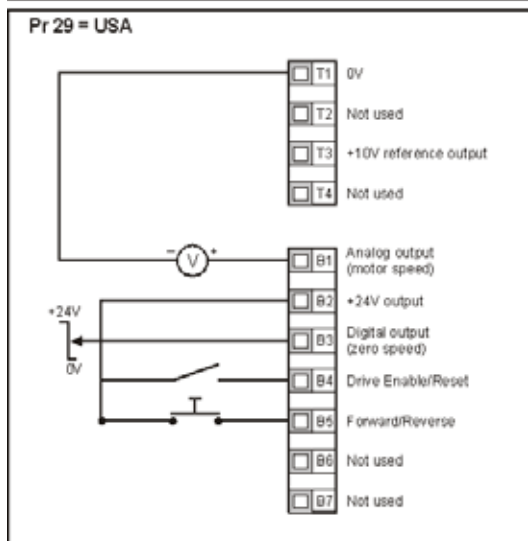
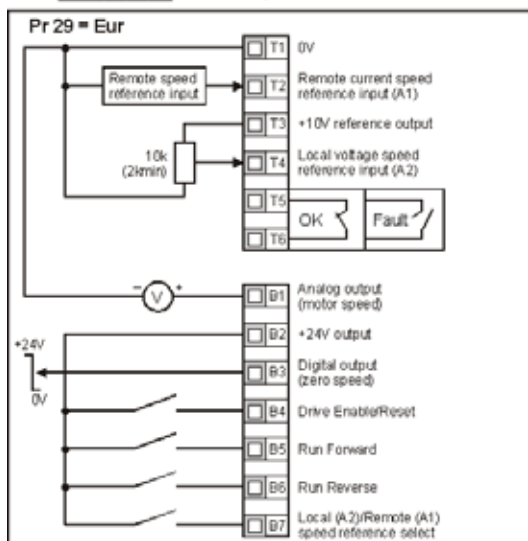
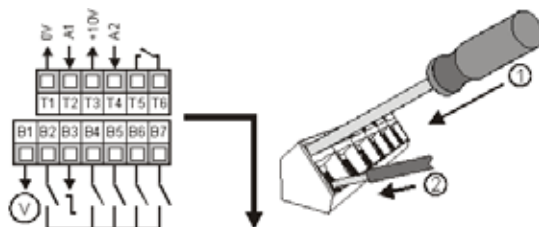

0472-0017-09